

FURUNO®

INSTALLATION MANUAL AUTOPILOT FAP-300

This manual provides the information necessary for the installation of the FURUNO FAP-300 Autopilot. For best results, install the unit by following the enclosed instructions in the order presented.

The installation of this unit requires certain electrical and mechanical skills. Any purchaser who has doubts about his or her technical abilities may wish to have this unit installed by a FURUNO representative or other qualified technician. Without a proper installation, no machine can perform its intended functions.



FURUNO ELECTRIC CO., LTD.
NISHINOMIYA, JAPAN

©FURUNO ELECTRIC CO., LTD.

9-52, Ashihara-cho,
Nishinomiya, Japan 662

Telephone: 0798-65-2111
Telefax: 0798-65-4200

•Your Local Agent/Dealer

All rights reserved. Printed in Japan

FIRST EDITION : SEP 1993
F : AUG. 28, 1996

(TAYA) PUB. No. IME-72370-F
FAP-300





SAFETY INSTRUCTIONS

"DANGER", "WARNING" and "CAUTION" notices appear throughout this manual. It is the responsibility of the installer of the equipment to read, understand and follow these notices. If you have any questions regarding these safety instructions, please contact a FURUNO agent or dealer.



DANGER

This notice indicates a potentially hazardous situation which, if not avoided, will result in death or serious injury.



WARNING

This notice indicates a potentially hazardous situation which, if not avoided, could result in death or serious injury.



CAUTION

This notice indicates a potentially hazardous situation which, if not avoided, could result in minor or moderate injury, or property damage.

 **WARNING**



Turn off the power at the mains switchboard before beginning the installation. Post a sign near the switch to indicate it should not be turned on while the equipment is being installed.

Fire, electrical shock or serious injury can result if the power is left on or is applied while the equipment is being installed.

 **CAUTION**



Ground the equipment to prevent electrical shock and mutual interference.

Confirm that the power supply voltage is compatible with the voltage rating of the equipment.

Connection to the wrong power supply can cause fire or equipment damage. The voltage rating appears on the label at the rear of the display unit.

Use the correct fuse.

Use of a wrong fuse can cause fire or equipment damage.

Table of Contents

1. SYSTEM CONFIGURATIONS

- 1. Hydraulic steering boat with engine pump.....3
- 2. Hydraulic steering boat with engine pump and valve unit4
- 3. Hydraulic steering boat with motor pump5

2. INSTALLATION OF UNITS

- 1. Installation Guidelines6
- 2. Rudder Reference Unit6
- 3. Remote Controller9
- 4. Rudder Telltale Unit 12
- 5. Color Plotter GP-3100 or GD-3100..... 14

3. SETTING DIP SWITCHES AND JUMPERS

- 1. Location of DIP switches and jumpers 15
- 2. Selecting item to display on analog (bar) indication..... 16
- 3. Selecting item to display on HEADING/COURSE indication..... 16
- 4. Registering the type of remote controller 17
- 5. Registering directional reference of heading data..... 17
- 6. Reducing the number of sea state settings to use..... 18
- 7. Enabling “Net towing AUTO mode” 18
- 8. Registering the function of the NAV mode 19
- 9. Selecting the navaid for “Advanced AUTO mode”..... 20
- 10. Setting the rudder angle limitation for AUTO mode..... 21
- 11. Enabling watch alarm 21
- 12. Default settings for DIP switches and Jumpers..... 22

4. NAVAID CONNECTION

- 1. NMEA 0183 sentences and the FAP-300 23

5. CHECKS AFTER INSTALLATION

- 1. Function test 24
- 2. Calibration of heading sensor 25

6. SETTING OF STEERING CHARACTERISTICS

- 1. Setting modes 27
- 2. Dockside setup..... 29
- 3. Sea-trial setup..... 32
- 4. Modifying the steering characteristics..... 33
- 5. Adjusting course changing speed 41

6. Record of steering characteristics	42
7. Customize the USER'S mode	43
7. MAINTENANCE	
1. Self-test	44
2. Checking LED status	51
EQUIPMENT LIST	52
INTERCONNECTION DIAGRAMS	S-1
SCHEMATIC DIAGRAM	S-2 to S-3
OUTLINE DRAWINGS	D-1 to D-10

1. SYSTEM CONFIGURATIONS

1. Hydraulic steering boat with engine pump

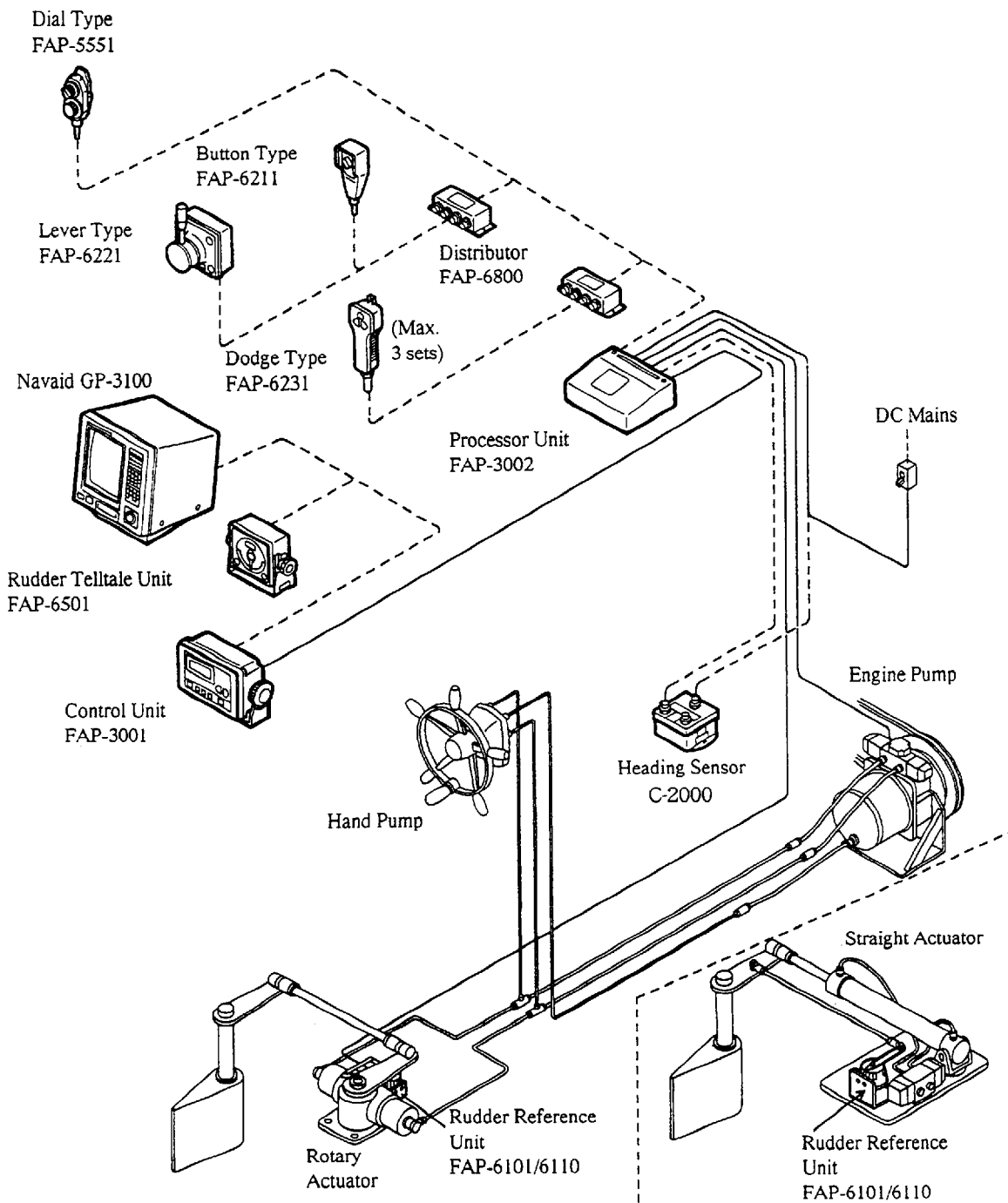

Fig. 1-1 Autopilot installation on hydraulic steering boat with engine pump

2. Hydraulic steering boat with engine pump and valve unit

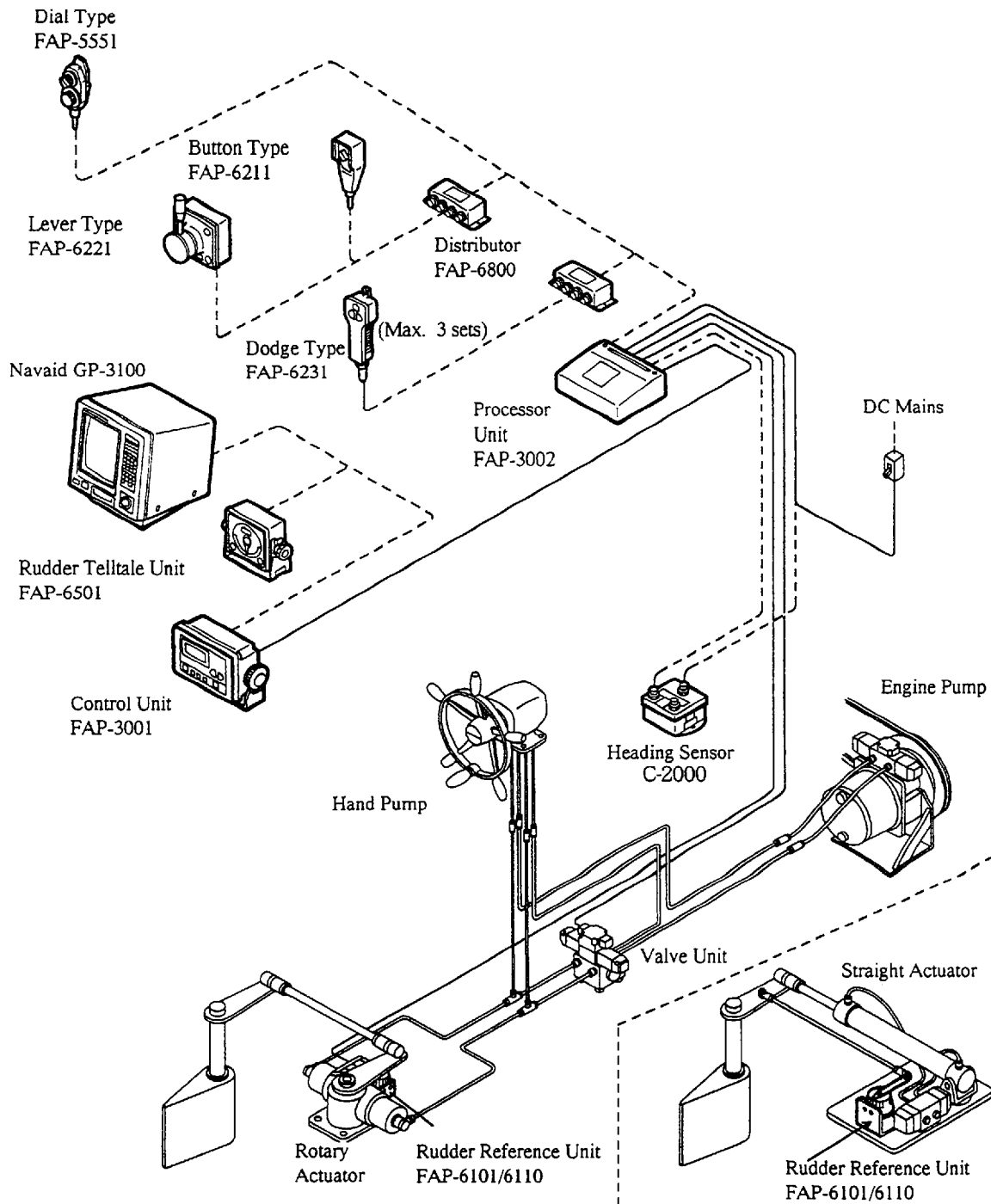

Fig. 1-2 Autopilot installation on hydraulic steering boat with engine pump and valve unit

3. Hydraulic steering boat with motor pump

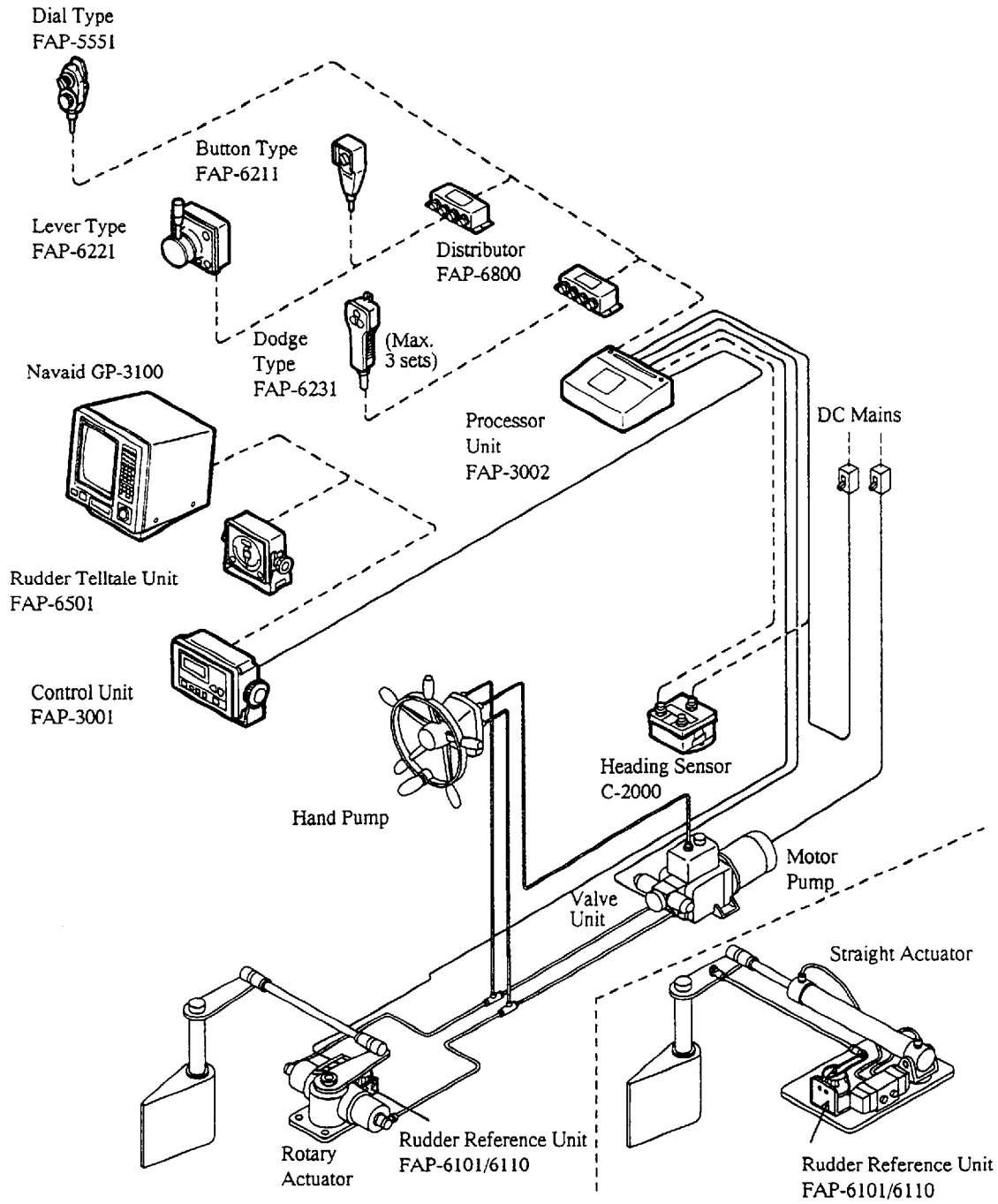

Fig. 1-3 Autopilot installation on hydraulic steering boat with motor pump

2. INSTALLATION OF UNITS

1. Installation Guidelines

Mounting considerations

When selecting mounting locations keep in mind the following points:

- Locate units away from direct sunlight.
 - Select a location free of water splash and rain.
 - Locate units away from direct air from air conditioner and heater.
 - The location should be well ventilated.
 - The temperature and humidity should be moderate and stable.
-

Notes on Cabling

1. Connect cables as shown in the interconnection diagram.
2. The power cable supplied with the FAP-300 is 5 meters long. It should run between the power supply (battery) and the processor unit via a circuit breaker (3A fuse incorporated) and be as short as practical. If a longer cable is required a larger wire size is necessary to minimize voltage drop.

Under no circumstance should the Processor Unit share the same power cable with other equipment; ship's power lines are notorious for being "dirty" electrically. The voltage can vary greatly as various heavy loads are placed on the line, and the power wiring is a prime source for interfering electrical signals (from such sources as alternators or generators, and other electronics equipment, like radars or echosounders).

3. All signal cables should be separated (not parallel) as far as possible from cables carrying rf (radio frequency) or pulsed signals. At least one meter (three feet) separation is recommended.
4. The supplied cables should not be lengthened. Otherwise the performance of the unit will be reduced.

2. Rudder Reference Unit (FAP-6101/FAP-6110)

Mounting considerations

- Leave sufficient space around all moving parts.

- The unit must be coupled to the rudder as shown on page D-10, where the following conditions are satisfied:

FAP-6101:	$Y2 < 600 \text{ mm}$	FAP-6110:	$Y2 < 350 \text{ mm}$
	$X1 = X2$		$X1 = X2$
	$Y1 = Y2$		$X1 = Y2$

- When the rudder is in neutral position:
 - The Rudder Reference Unit should also be neutral (centered).
 - The arm of Rudder Reference Unit should be at a right angle to the tie rod.
 - The rudder stock should be perpendicular with the tie rod.
- After completing the installation, coat both ends of the tie rod with grease.

Mounting the unit on the same side as rudder

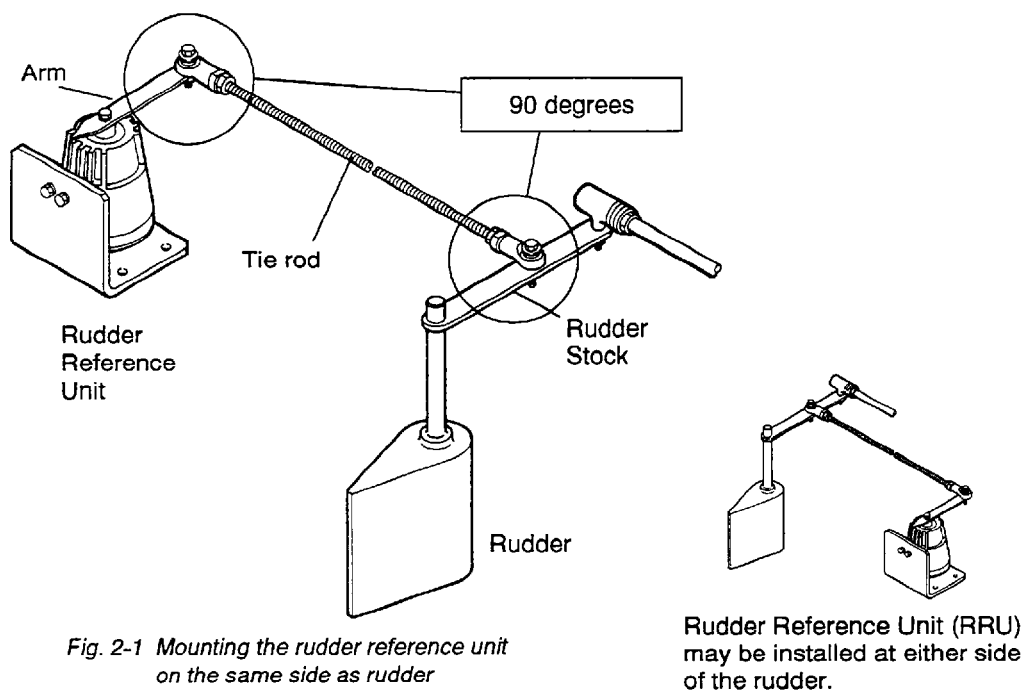

Mounting on the side opposite to rudder

When installing the Rudder Reference Unit on the side opposite to the rudder as shown below, change the wire connection. Open the bottom plate of the Rudder Reference Unit and exchange the brown and yellow wires at J6 on CPU Board. Refer to the figure on the next page.

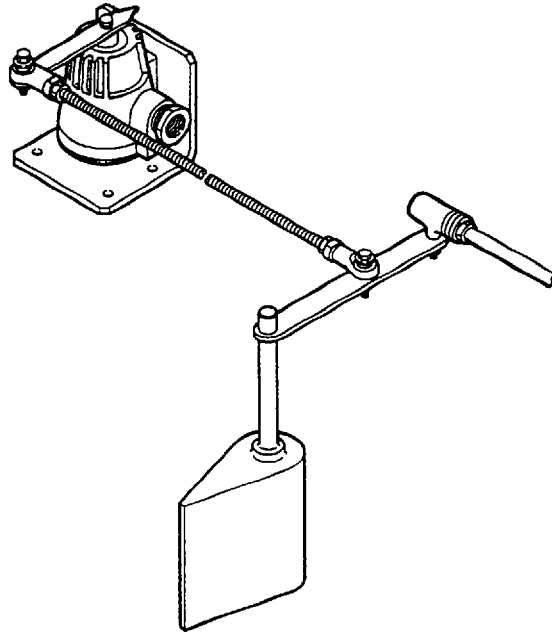

Fig. 2-2 Mounting the RRU on the side opposite to rudder

CAUTION

Install the Rudder Reference Unit on the same side as the rudder when the rudder angle limitation inherent in the boat's structure is more than 45 degrees.

Steering the rudder more than 45 degrees with the unit installed on the side opposite to the rudder may exceed the turning limit of the arm, damaging the unit.

Connections

- Rudder Reference Unit on same side as rudder

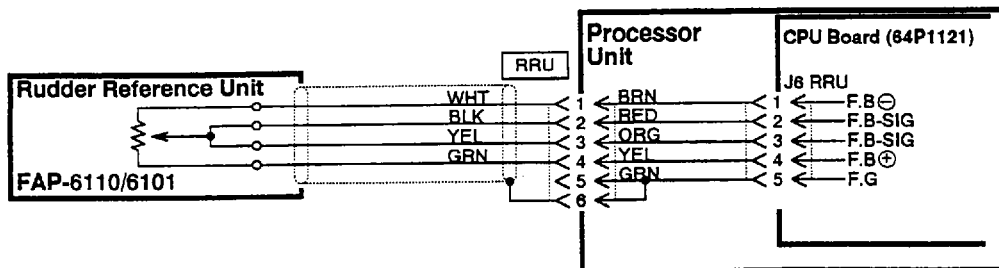

Fig. 2-3 Connections when the rudder reference unit is installed on same side as rudder.

- Rudder Reference Unit on side opposite to rudder

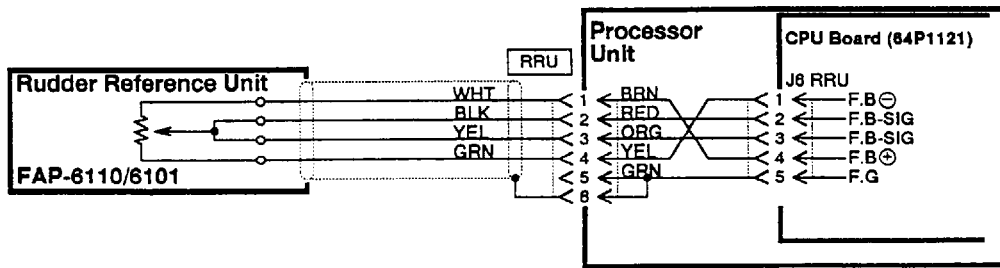

Fig 2-4 Connections when the rudder reference unit is installed on side opposite to rudder.

3. Remote Controller

To hand-hold FAP-5551

If you desire handheld operation invert the switch and dial so that they are readable. This can be done by unfastening the four screws shown below. Note that the switch and dial are inserted into the controller body with O-rings. Be careful not to damage the O-rings.

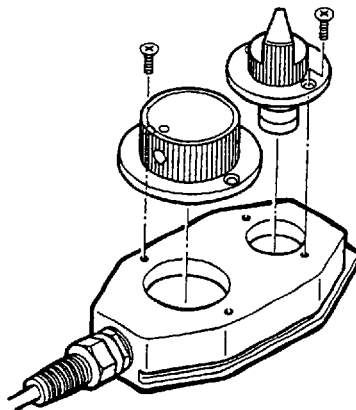

Fig. 2-5 Inverting the switch and dial on the FAP-5551

To use multiple non-follow-up-type remote controllers

The Distributor FAP-6800 enables connection of three NFU (Non-Follow-Up)-type remote controllers to the Processor Unit. Note that only one FU (Follow-Up)-type remote controller may be connected.

Example connections

FAP-5551 dial-type remote controller

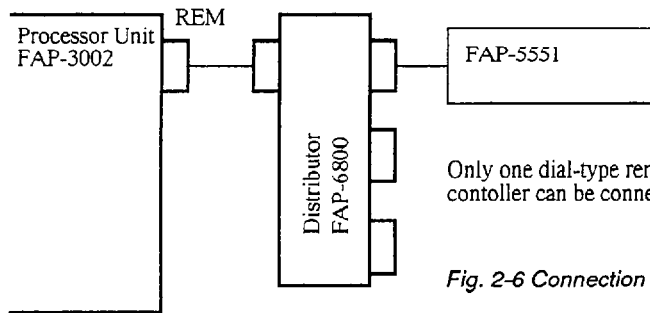

Only one dial-type remote controller can be connected.

Fig. 2-6 Connection of single dial type remote controller

FAP-6211 or FAP-6221 button/lever-type remote controllers

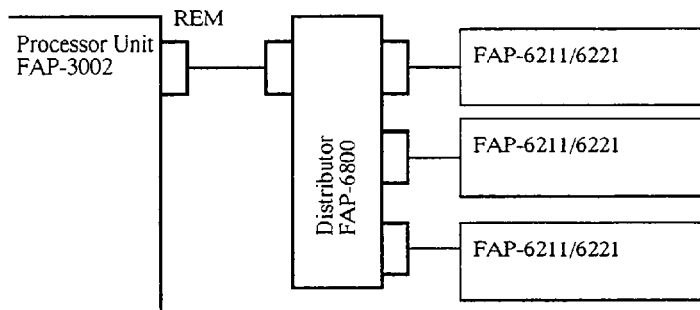

Fig. 2-7 Connection of three button/lever-type remote controllers

FAP-6231 dodge-type remote controller

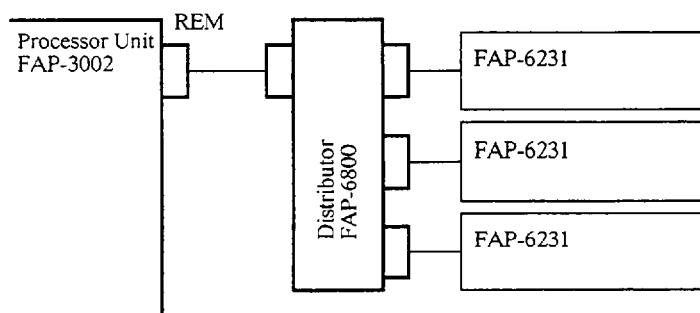

Fig. 2-8 Connection of three dodge-type remote controllers

The following connections are not possible.

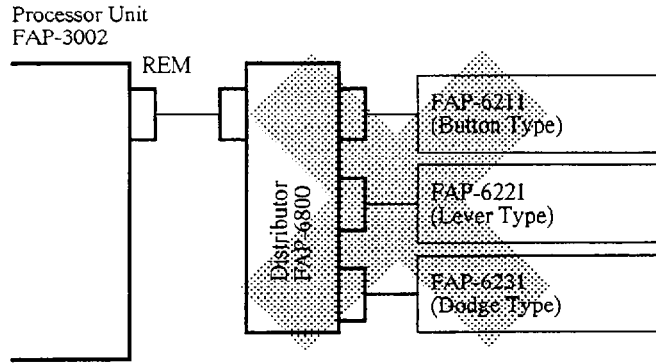

Fig. 2-9 Different types of remote controllers cannot be connected

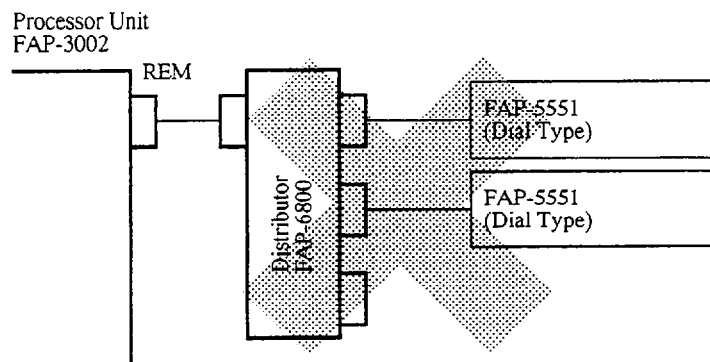

Fig. 2-10 Only one dial type can be connected

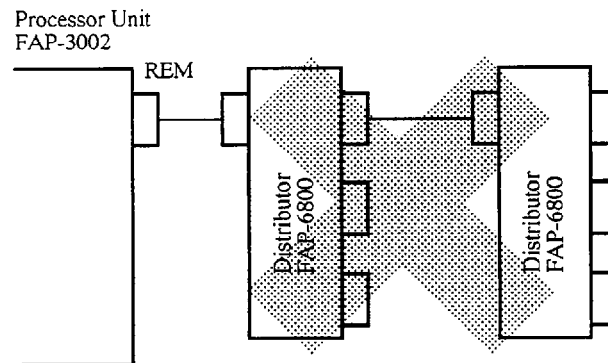

Fig. 2-11 Multiple distributors cannot be connected

4. Rudder Telltale Unit (FAP-6501)

Receiving autopilot data

The FAP-300 can output autopilot data to either the GD-3100/GP-3100 Video Plotters or the FAP-6501, through pins #3 and #4 of the DATA IN/OUT connector. The unit to output data to is determined by the setting of Jumper JP1 on the I/F Board in the Control Unit. To output data to the FAP-6501, cut the pattern and attach a jumper wire. See Fig.2-12.

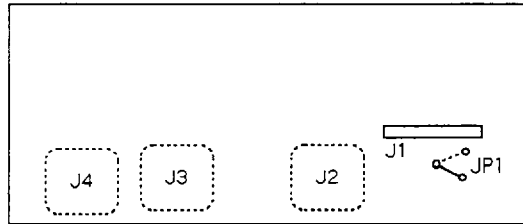

Fig. 2-12 Location of jumper JP1 on I/F board in Control Unit

Data output to	Jumper JP1
GP-3100 or GD-3100	No modification necessary (default setting).
FAP-6501	Referring to Fig. 2-12, cut pattern (solid line) and attach jumper wire (dashed line).

Connection of power supply

The FAP-6501 requires an external power supply whose output voltage is 10.8 to 30Vdc. Connect the power supply to the FAP-6501 as shown in Fig. 2-13.

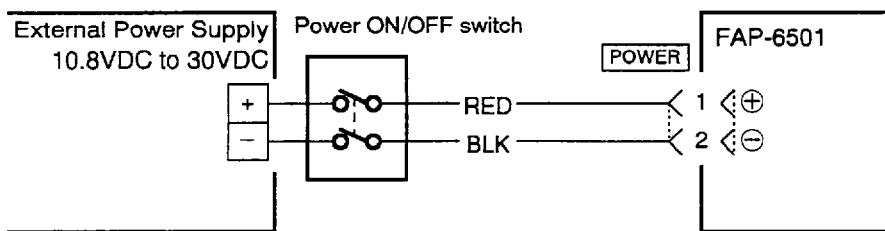

Fig. 2-13 Connection of power supply to the FAP-6501

Connection

- Connection of Control Unit only

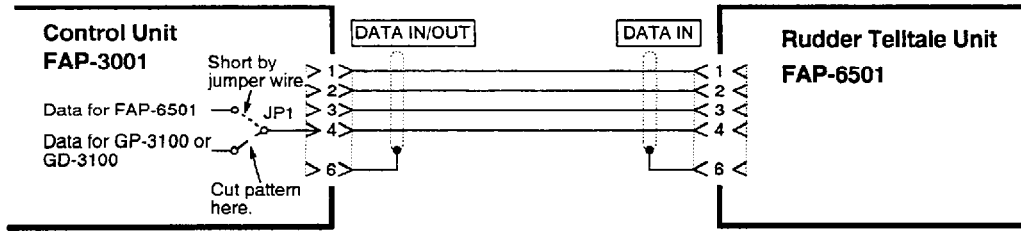

Fig. 2-14 Connecting FAP-6501 to FAP-3001

- Connection of Control Unit and navaid

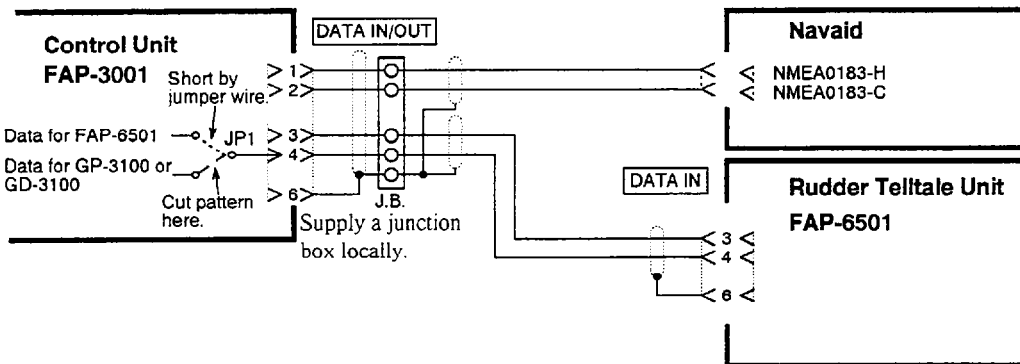

Fig. 2-15 Connecting FAP-6501 and navaid to FAP-3001

Multiple unit installation

A maximum of three Rudder Telltale Units may be connected in series as shown in Fig. 2-16.

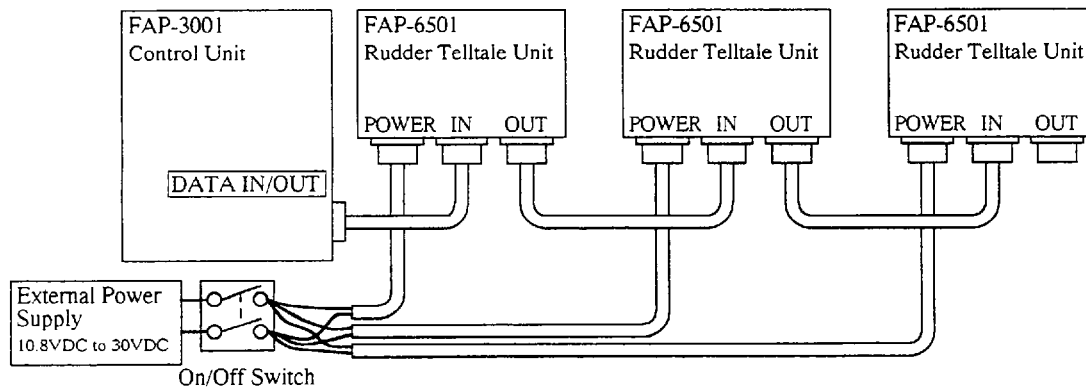

Fig. 2-16 Multiple rudder telltale unit installation

5. Color Plotter GP-3100 or GD-3100

Receiving autopilot data

The FAP-300 can output data to either the GD-3100/GP-3100 Video Plotters or the data to FAP-6501, through pins #3 and #4 of the DATA IN/OUT connector. The unit to output is determined by the setting of Jumper JP1 on the I/F Board in the Control Unit. The solid line of JP1 is shorted at the factory to connect the video plotter.

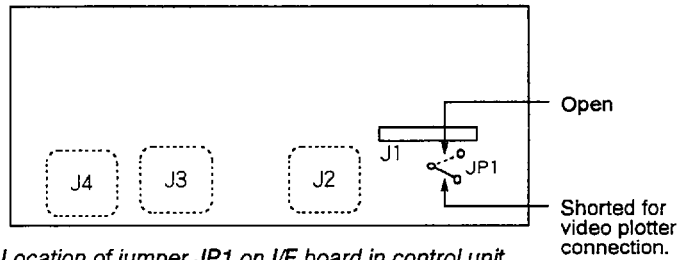

Fig. 2-17 Location of jumper JP1 on I/F board in control unit

Data output to	Jumper JP1
GP-3100 or GD-3100	No modification necessary (default setting).
FAP-6501	Referring to Fig. 2-17, cut pattern (solid line) and attach jumper wires (dashed line).

Connections

Connect GP-3100 or GD-3100 to the Control Unit as shown in Fig. 2-18.

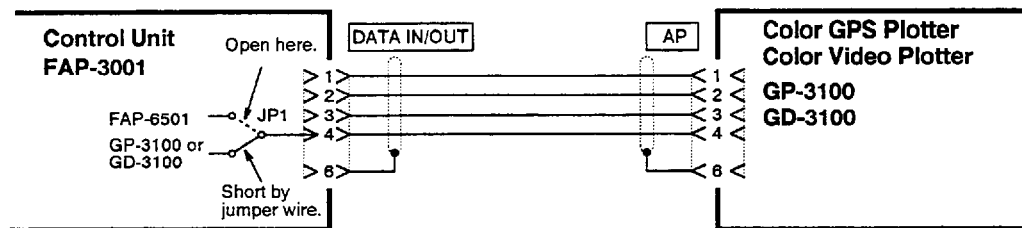

Fig. 2-18 Connecting GP-3100 or GD-3100 to FAP-3001

3. SETTING DIP SWITCHES AND JUMPERS

This chapter describes how to set up the the FAP-300 according to usages desired, by presetting DIP switches and jumpers. Adjustment may not be necessary depending on setting desired. Section 12 of this chapter (page 22) lists default settings for DIP switches and jumpers. Refer to it to determine if adjustment is necessary. Before changing any settings, turn off the power.

1. Location of DIP switches and jumpers

DIP switch in control unit

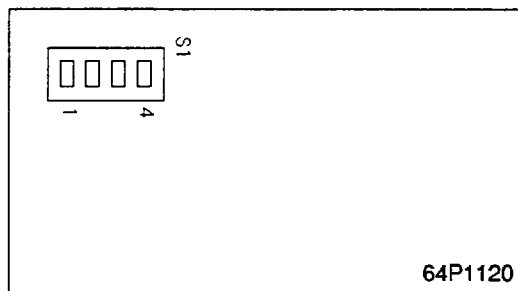

Fig. 3-1 Location of the DIP switch on LCD board in control unit

DIP switch and jumpers in processor unit

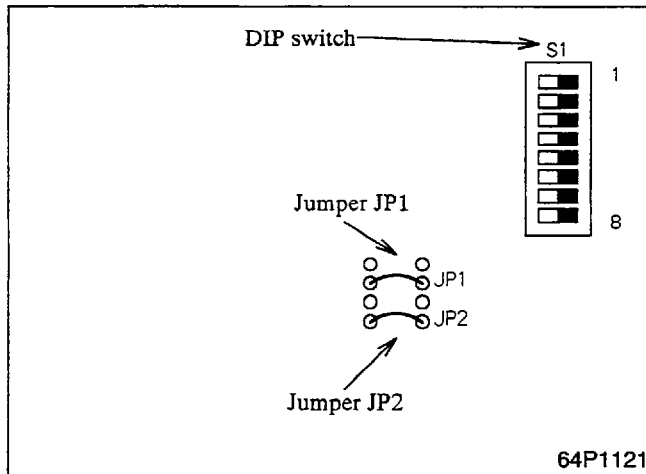

Fig. 3-2 Location of the DIP switch and jumpers on CPU board in processor unit

2. Selecting item to display on analog (bar) indication

Introduction

The default setting shows rudder angle, course deviation or cross-track error depending on the steering mode. When only rudder angle is needed, the indication may be fixed for rudder angle.

Procedure

Set the #1 switch of the DIP switch on the LCD Board (64P1120) in the Control Unit according to item to display on the analog indication.

Item to display on analog indication	Segment 1
Rudder angle, Course deviation or Cross-track error depending on the steering mode	OFF
Rudder angle only irrespective of the steering mode	ON

3. Selecting item to display on HEADING/COURSE indication

Introduction

The default setting shows heading or course depending on the steering mode. When only course is needed, the indication may be fixed for course.

Procedure

Set the #2 switch of the DIP switch on the LCD Board (64P1120) in the Control Unit according to item to display on HEADING/COURSE indication.

Item to display on HEADING/COURSE indication	Segment 2
Heading or course depending on the steering mode	OFF
Course only irrespective of the steering mode	ON

4. Registering the type of remote controller

Introduction

When a remote controller is connected, register the type.

Procedure

Set the #1 and #2 switches of the DIP switch on the CPU Board (64P1121) in the Processor Unit according to type of remote controller connected.

Type of remote controller connected	Segment 1	Segment 2
FAP-5551	OFF	OFF
FAP-6211	ON	OFF
FAP-6221	ON	OFF
FAP-6231	ON	ON

Do not disturb the settings of segments 1 and 2 when no remote controllers are installed.

5. Registering directional reference of heading data

Introduction

Register directional reference of heading sensor.

Procedure

Set the #3 switch of the DIP switch on CPU Board (64P1121) in the Processor Unit according to output of heading sensor.

Output of heading sensor	Segment 3
Magnetic bearing	OFF
True bearing (Gyrocompass)	ON

6. Reducing the number of sea state settings to use

Introduction

The FAP-300 can register three sets of steering characteristics to meet various sea conditions. They are SEA STATE ①, ② and ③. When the sea condition does not change much and changing of the sea state number is not necessary, you may reduce the number of sea state settings to use to one.

Procedure

Set the #4 switch of the DIP switch on CPU Board (64P1121) in the Processor Unit according to number of sea state settings to use.

Number of sea state settings to use	Segment 4
Three	OFF
One	ON

When the number of sea states is reduced to one, the function of the SEA STATE key changes. Every pressing of the key enables adjustment of sea state. To escape from the sea state setting display, press the **ALARM RESET** key.

7. Enabling "Net towing AUTO mode"

Introduction

When a boat tows a net its stern is "dragged" by the net. This causes the boat to stray from its intended course. To keep the boat on course, you need to adjust the trim manually, which can be bothersome. If you do not want to be bothered with trim adjustments, you can enable the net towing AUTO steering feature. It is indispensable for trawlers.

Procedure

Turn on the #5 switch of the DIP switch on the CPU Board in the Processor Unit to enable this feature.

"Net Towing AUTO"	Segment 5
Disable	OFF
Enable	ON

8. Registering the function of the NAV mode

The function of the NAV mode can be one of the following.

Cross track error control

The default setting is “Cross track error control”. The FAP-300 controls the boat to decrease the cross track error. The boat will follow the course between FROM and TO waypoints.

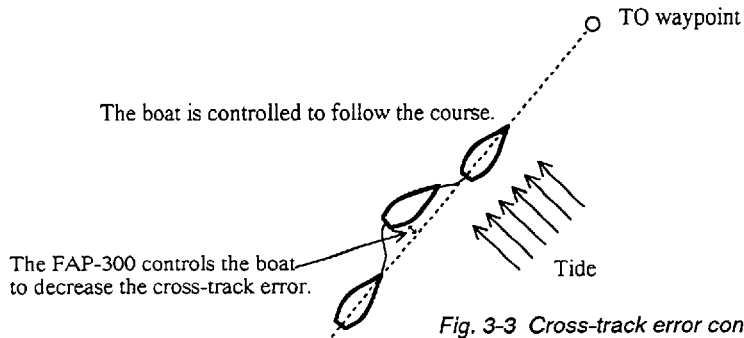

Fig. 3-3 Cross-track error control in the NAV mode

When the remote controller is turned off, FAP-300 controls the boat to return to the original course.

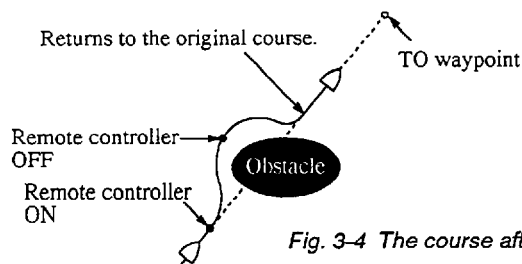

Fig. 3-4 The course after using remote controller

Course deviation control

The FAP-300 controls the boat to always head to the TO waypoint. The course for waypoint navigation is ignored.

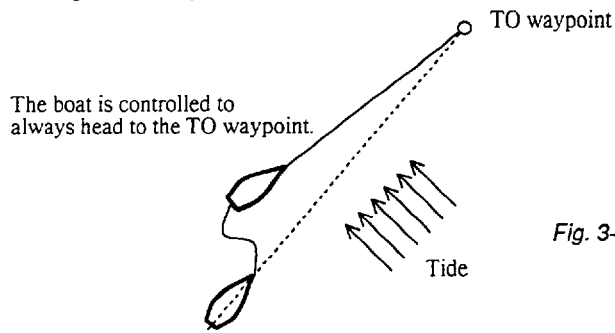

Fig. 3-5 Course deviation control in the NAV mode

The FAP-300 ignores the original course and directly heads to the TO waypoint. The boat will not return to the original course.

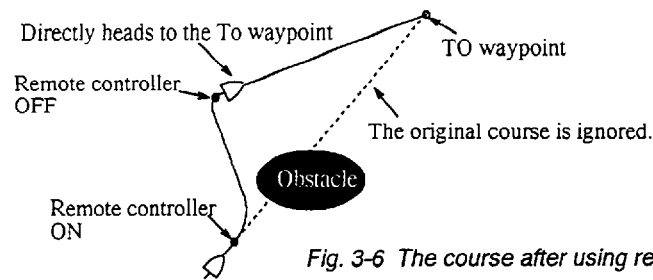

Fig. 3-6 The course after using remote controller

When connected to GP-3100 or GD-3100

When the FAP-300 is connected to GP-3100 or GD-3100, the function is “Cross-track error control”. However, at the moment remote controller is turned off, the control is “Course deviation control”. The GP-3100 or GD-3100 sets the new course when the remote controller is turned off.

Procedure

Set the #6 switch of the DIP switch on CPU Board (64P1121) in the Processor Unit according to NAV mode function desired.

NAV mode control	Segment 6
Cross track error control	OFF
Course deviation control	ON

9. Selecting the navaid for “Advanced AUTO mode”

Introduction

The navaid for the Advanced AUTO mode may be GP-3100 or GD-3100 or any navigational equipment transmitting GLL (NMEA0183). Connecting GP-3100 or GD-3100 enables smoother control of the boat.

Procedure

Set the #7 switch of the DIP switch on the CPU Board (64P1121) in the Processor Unit according to the navaid connected.

Navaid for “ADVANCED AUTO MODE”	Segment 7
GLL (NMEA 0183) outputting navaid	OFF
GP-3100 or GD-3100	ON

10. Setting the rudder angle limitation for AUTO mode

Introduction

Narrow the rudder angle limitation when you can not run the boat straightly in spite of the steering characteristics from the front panel for AUTO mode.

Procedure

Set Jumper JP1 on the CPU Board (64P1121) in the Processor Unit for desired rudder angle limitation.

Rudder limitation for AUTO and mode	Jumper JP1
10 degrees	Open
20 degrees	Short (Default)

11. Enabling watch alarm

Procedure

The watch alarm warns the helmsman to check the autopilot. To enable the watch alarm, open the Jumper JP2 on the CPU Board (64P1121) in the Processor Unit. To disable the watch alarm, short JP2.

Note that the watch alarm cannot be disabled from the front panel of the Control Unit; only the aural alarm can be silenced there.

"Watch alarm"	Jumper JP2
Enable	Open
Disable	Short

12. Default settings for DIP switches and jumpers

The default settings for the DIP switches and jumpers are as follows.

Control unit

Dip switch (64P1120)

Segment	Default
1	OFF
2	OFF
3	OFF
4	OFF

Jumper (64P1122)

Jumper	Default
JP1	shorted

Processor unit (64P1121)

Dip switch (64P1121)

Segment	Default
1	OFF
2	OFF
3	OFF
4	OFF
5	OFF
6	OFF
7	OFF
8	OFF

Jumper (64P1121)

Jumper	Default
JP1	Shorted
JP2	Shorted

4. NAVAID CONNECTION

1. NMEA 0183 sentences and the FAP-300

Immediately after turning on the power, the FAP-300 does the following.

- (1) Collects nav. data for a certain period,
- (2) Examines which of the following six sentences are contained in the collected data;

- | | | |
|------------|----------|------|
| 1. BWC+XTE | +VTG+AAM | +GLL |
| 2. BOD+XTE | +VTG+AAM | +GLL |
| 3. APB | +VTG | +GLL |
| 4. RMB | +VTG | +GLL |
| 5. APA | +VTG | +GLL |
| 6. GLL | | |

NAV mode operation is possible without VTG (ship's speed) and AAM (arrival alarm). Inputting them however enables much smoother control of the boat. The GLL (position data) is required for the ADVANCED AUTO mode operation.

- (3) The FAP-300 chooses the format with the highest priority. "1" to "6" are order of priority; 1 for highest, 6 for lowest.

The FAP-300 thereafter fetches only the data selected, until it is turned off. For NAV mode operation, one of "1." to "5." is required.

— **NOTE** (If data with various talker IDs are received.):—

Talkers are prioritized in the order of GP-LC-DE-LA-TR-II. The FAP-300 examines all the incoming data for a certain period after power-on, then judges which has the highest priority. The FAP-300 thereafter picks up only the data with that talker ID until the power is turned off. Even if the data does not come for an extended period of time, the FAP-300 does not switch to a different talker ID because it is dangerous if data consistency is lost. Safety comes first!

5. CHECKS AFTER INSTALLATION



1. Function test

After installing the unit, conduct the following function test with the vessel moored in a harbor.

IMPORTANT

1. The FUNCTION TEST must be conducted by a person who has thorough knowledge of the autopilot's functions.
2. Make sure that there is no one nor any obstruction in the area near the rudder when performing the test.
3. If the rudder is driven continually, immediately turn off the FAP-300 or press . The FAP-300 may be faulty or not installed properly.

Procedure

- | | |
|---|---|
| (1) Turn off the FAP-300. Steer the wheel from hard over to hard over, then return it to neutral. | The rudder shall move smoothly without undue stiffness. |
| (2) Turn on the FAP-300 by pressing  . | The STBY mode indication "S" shall appear. |
| (3) Steer the wheel from hard over to hard over, then return it to neutral. | The rudder angle indication shall change accordingly. |
| (4) Compare the heading indication (digital) with the compass reading. | The heading indication shall be close to that of the compass reading. |
| (5) Press  . | The AUTO mode indication shall appear. |
| (6) By adjusting the course control, increase the course reading by 10 degrees in the starboard direction. | The analog meter shall indicate a 10 degree course change to starboard. |

(7) Press .

The analog meter shall indicate correct rudder angle in starboard direction.

(8) Press .

(9) By adjusting the course control, decrease the course reading by 10 degrees in the port direction.

The analog meter shall indicate 10 degree course deviation to port.

(10) Press .

The analog meter shall indicate correct rudder angle in port direction.

(11) Press .

(12) Turn on the remote controller.

The REM mode indication shall appear.

(13) Slowly turn the steering dial on the remote controller from hard over to hard over.

The rudder angle (analog) indication shall change accordingly.
The appropriate rudder direction indication shall light.

(14) Turn off the remote controller.

The AUTO mode shall be recalled.

(15) If a navaid is connected to the FAP-300;

Place the navaid in the fully operating condition and select a TO WAYPOINT.
(Assign the present position to FROM WAYPOINT.)

Press .

The NAV mode indication shall appear. (The "N" sign should not be blinking.)

The course reading on the FAP-300 shall be the same as the one presented on the navaid.

(16) Turn off the FAP-300.

In addition to the above-mentioned function test, it is always a good idea to proceed out of the harbor and check FAP-300's performance in every mode.

2. Calibration of heading sensor

Calibrate the heading sensor referring to the manual for the heading sensor. Most of the weaving problems may be solved by compensating the heading sensor.

6. SETTING OF STEERING CHARACTERISTICS

This chapter shows you how to adjust the autopilot to match the steering characteristics of your boat. The procedure you will use to make the adjustment is shown by the flow chart which follows.

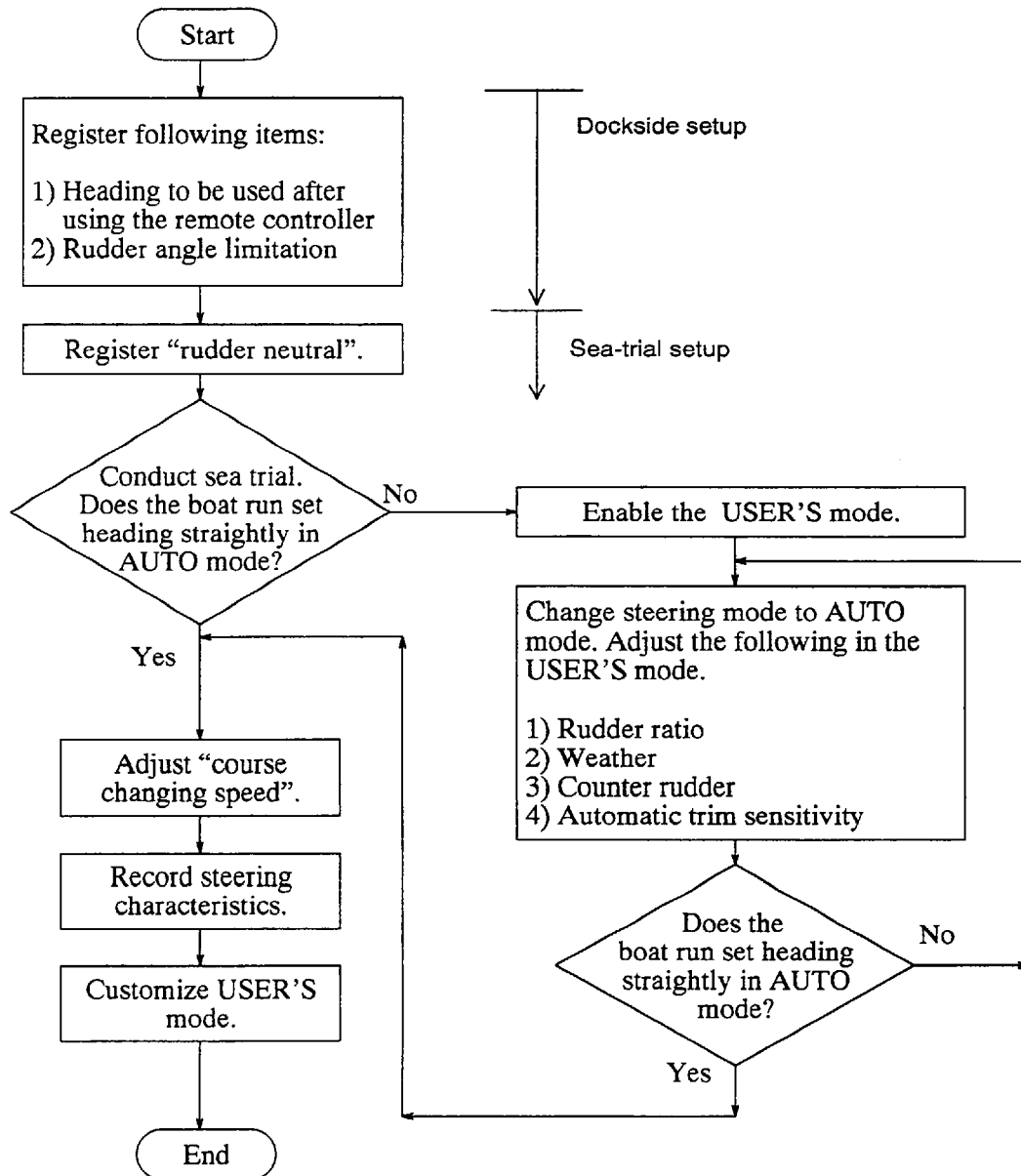

1. Setting modes

The FAP-300 has two modes for adjustment of steering characteristics and functions: the INITIAL SETTING mode and the USER'S mode. The INITIAL SETTING mode, consisting of nine items, mainly sets initial steering characteristics and functions. The USER'S mode contains five of the items which appear in the INITIAL SETTING mode. It is mostly used for adjustment of steering characteristics during the sea trial.

INITIAL SETTING mode

How to confirm the initial setting

1. Hold down  for more than 2 seconds to enable the INITIAL SETTING mode. The display for rudder ratio setting appears.

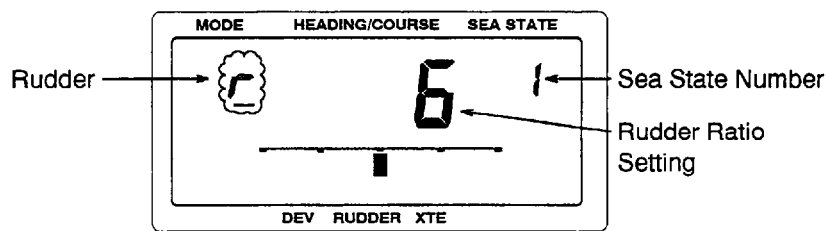





Fig. 6-1 Display for adjusting rudder ratio

2. Press  to select other item to confirm the setting.
Each press of the key changes the display in the sequence shown in Fig. 6-2. You may also use the  key to select item, in which case the sequence is reversed.
3. Press  to escape.

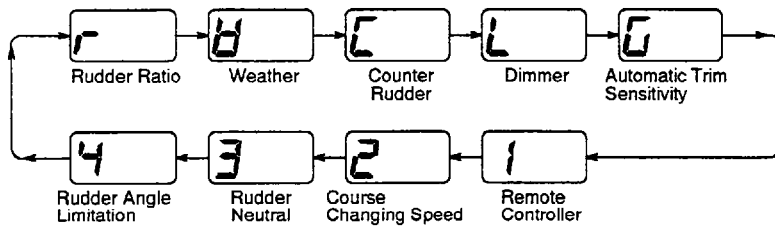

Fig. 6-2 Items in the initial setting mode

Description of initial settings

Item	Adjustment	Default		
		①	②	③
Rudder Ratio	Adjust the amount of rudder reaction versus course deviation.	5	6	7
Weather	Prevent frequent steering in bad weather.	2	4	6
Counter Rudder	Prevent excessive turning by inertia when changing course.	0	0	2
Dimmer	Adjust the illumination of keys and LCD.	1		
Automatic Trim Sensitivity	Adjust the sensitivity for monitoring the boat's trim.	6		
Remote Controller	Assign heading to be used after using the remote controller.	H		
Course Changing Speed	Adjust the course changing speed by the FAP-300.	3		
Rudder Neutral	Set the rudder neutral position.	000		
Rudder Angle Limitation (REM and DODGE modes)	Limit the maximum rudder angle, for safety in REM and DODGE modes.	8		





Sea State 1, 2, 3:

The combination of rudder ratio, weather and counter rudder is known as sea state. You can register three sets of sea states, and use the one which best matches current sea condition. More on this later.

USER'S mode

This mode enables adjustment of steering characteristics while operating the FAP-300 in the AUTO or NAV mode; namely, when cruising on the open sea.

Basic setting procedure

1. Press  key to select sea state number.
2. Hold down the  key more than 2 seconds to enable the USER'S mode.
3. Press the  key to select item to adjust. Fig 6-3 shows the items available and the selection sequence when pressing the  key.

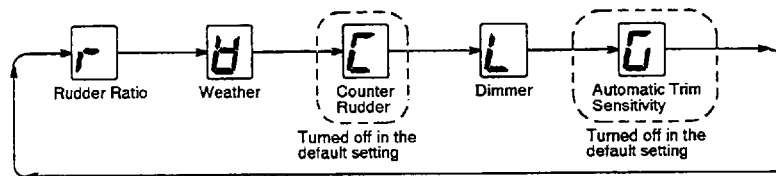



Fig. 6-3 Items in the user's mode

4. Operate the control dial to select setting.
5. Press  to select another item, or press  to escape.

As shown in Fig. 6-3 the USER'S mode contains five items. In the default setting, counter rudder and automatic trim sensitivity are disabled since frequent adjustment of them is not necessary. You can enable them, or disable other items, as desired. More on this later.

2. Dockside setup

In this section, you will register the following:

- 1) Heading to be used after using the remote controller
- 2) Rudder angle limitation

Remote controller (Assign heading to be used after using the remote controller.)

Function of remote controller

The heading to be used after using the remote controller can be one of the following:

Setting	H	C
Function	The heading at the moment the remote controller is turned off.	The previous heading before using the remote controller.

Setting: H (Default)

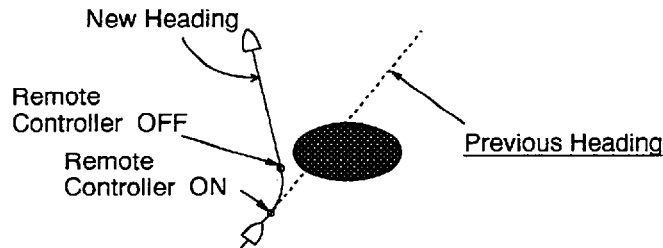

Fig. 6-4 How the "H" setting works

Setting: C

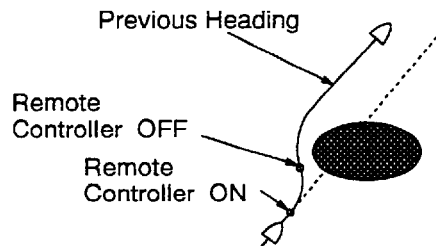



Fig. 6-5 How the "C" setting works

Procedure

1. Hold down  for more than 2 seconds to go into the INITIAL SETTING mode.
2. Press  several times to show the display which follows.

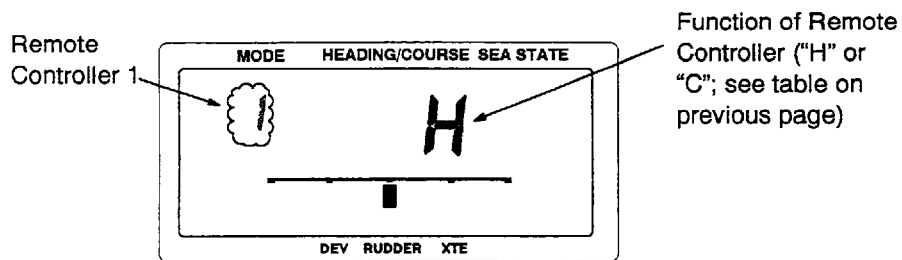

Fig. 6-6 Display for selecting the function of remote controller

3. Select the function with the control dial.

Rudder angle limitation (for the REM and DODGE modes)

About rudder angle limitation

In the REM or DODGE mode, usually a wide range of rudder angles are used, and therefore a larger number should be entered. However, the setting must not exceed the rudder limit angle which is inherent for your boat.

A number from “2” to “9” may be entered. The actual rudder angle limitation in degrees is obtained by multiplying the number by five;

Setting	2	3	4	5	6	7	8	9
Rudder Limit	± 10°	± 15°	± 20°	± 25°	± 30°	± 35°	± 40°	± 45°

Procedure

4. Press  several times to show the display which follows.

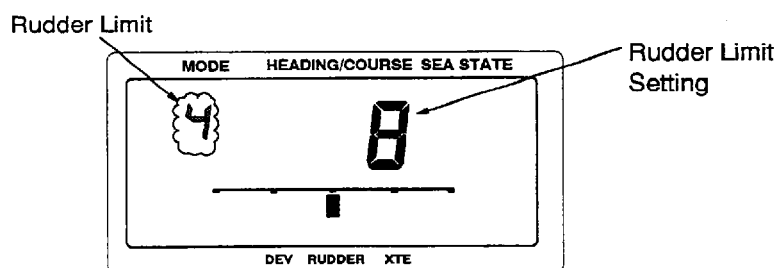





Fig. 6-7 Display for adjusting the rudder angle limitation in REM and DODGE modes

5. Change the value with the control dial.
6. Press  to escape from the INITIAL SETTING mode.

NOTE

The rudder angle limitation for the AUTO and NAV modes may be preset by a jumper in the Processor Unit. Refer to “10. setting the rudder angle limitation for AUTO mode” in chapter 3.

Check after setting rudder angle limitation

1. Press  to go into the STBY mode.
2. Press  to steer the rudder to hard port.

Confirm that the rudder driving indication on the front panel distinguishes. If it doesn't,

the rudder angle limitation exceeded the rudder limit angle which is inherent for the boat. Decrease the setting by one.

3. Press  to steer the rudder to hard starboard.

Confirm that the rudder driving indication on the front panel distinguishes. If it doesn't, the rudder angle limitation exceeded the rudder limit angle which is inherent for the boat. Decrease the setting by one.



3. Sea-trial setup

Now it is time to check if your boat can run a set heading straightly with default steering characteristics, on the open sea. This trial should be conducted in calm water where there is no boat traffic or obstructions. You will do the following to determine suitability of default steering characteristics.

- 1) Register "rudder neutral".
- 2) Run your boat in the AUTO mode to see if it runs set heading straightly.

Registering rudder neutral

Procedure

1. Hold down  for more than 2 seconds to enable the INITIAL SETTING mode.
2. Press  several times to show the display which follows.

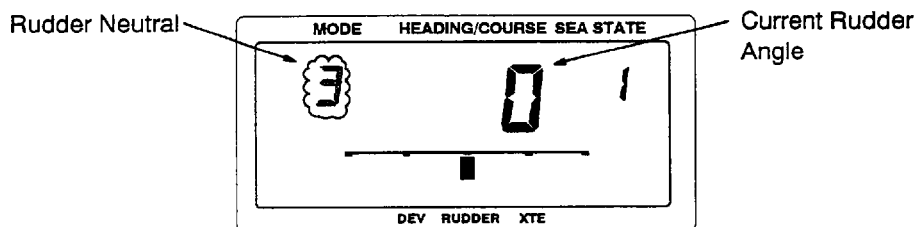





Fig. 6-8 Display for adjusting rudder neutral

3. Manually steer the boat straightly on steady course.
4. Press . The current rudder angle is registered as the rudder angle to run the boat straightly.
5. Press  to escape.

Checking the boat's track

Procedure

1. Turn on the power and press the  key to go into the AUTO mode.
2. Observe your boat's track.

If it runs the set heading straightly, the (default) steering characteristics match those of your boat's. No adjustment of steering characteristics is necessary. Proceed to "5. Adjusting course changing speed". If it weaves, go to the next section to modify steering characteristics.

4. Modifying the steering characteristics

This section shows you how to modify steering characteristics. You will do the following.

- 1) Enable the USER'S mode.
- 2) Adjust "rudder ratio", "weather", "counter rudder" and "automatic trim sensitivity" to run the boat straightly on a set heading.

Enabling the USER'S mode

Introduction

To adjust steering characteristics in the sea trial, enable the USER'S mode. The USER'S mode contains five items: rudder ratio, weather, counter rudder, dimmer and automatic trim sensitivity. In the default setting, counter rudder and automatic trim sensitivity are disabled. Turn them on here to enable adjustment of them.

Procedure

1. Hold down the  key until the display which follows appears.

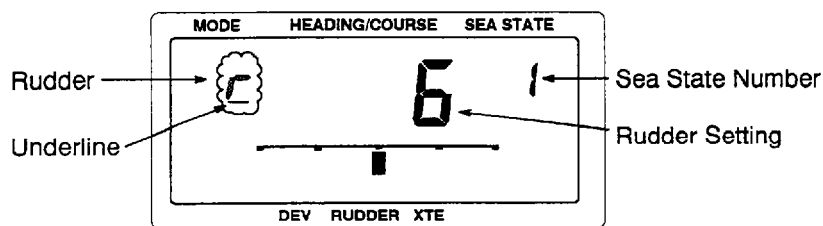



Fig. 6-9 Display for adjusting rudder ratio

2. Press  to select COUNTER RUDDER.

3. Press **SEA STATE** to set underline under **C**.
4. Enable AUTOMATIC TRIM SENSITIVITY as well.
5. Press **ALARM RESET** to escape.

Setting for SEA STATES ①, ② and ③

First set the steering characteristics (WEATHER, RUDDER RATIO and COUNTER RUDDER) for sea state ①. Then set them for SEA STATES ② and ③. Note that you should select sea state number before going into the USER'S mode.

Assign any sea and vessel loading conditions to ② and ③, such as "AUTO+Heavy Load" and "NAV". Enter settings referring to the table below. When sea/loading conditions change, use the appropriate SEA STATE (② or ③). Modify the settings to suit the actual situation.

The default settings for the steering characteristics are for the following sea states.

SEA STATE ① AUTO+Calm sea
 SEA STATE ② AUTO+Normal sea
 SEA STATE ③ AUTO+Rough sea

The settings for sea states ② and ③ may be changed, for example;

SEA STATE ① AUTO+Calm sea
 SEA STATE ② AUTO+Rough sea
 SEA STATE ③ AUTO+Full load

or

SEA STATE ① AUTO+Calm sea
 SEA STATE ② AUTO+Full load
 SEA STATE ③ NAV

Guidelines for setting sea states ② and ③

Item	If "AUTO+Rough sea" is assigned to ② or ③;	If "AUTO+Full load" is assigned to ② or ③;	If "NAV" is assigned to ② or ③;
WEATHER	Set the value 1 to 2 settings higher than ①.	Set the value 1 to 2 settings higher than ①.	Set the value 1 to 2 settings higher than ①.
RUDDER RATIO			Set the same value as ①.
COUNTER RUDDER	Set the same value as ①.		Set the same value as ①. (See note below.)

Note: In case of route navigation, non-zero setting should be used to prevent over-turning to return to course.

Rudder ratio (Adjust the amount of rudder reaction versus course deviation.)

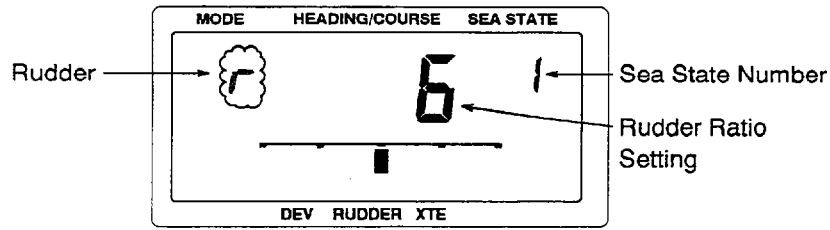

Fig. 6-10 Display for adjusting rudder ratio

About rudder ratio

When the boat's heading deviates from the set course, the FAP-300 adjusts the rudder to correct it. The rudder angle (number of degrees) which is steered against every degree of course deviation is known as the rudder ratio. Nine rudder ratio settings are available as tabulated below.

Setting	1	2	3	4	5	6	7	8	9
Rudder Ratio	0.1	0.2	0.3	0.4	0.6	0.8	1.0	1.2	1.5

The following illustrations show how many degrees the FAP-300 steers the rudder in order to nullify 10 degrees of course deviation with various settings of the rudder ratio:

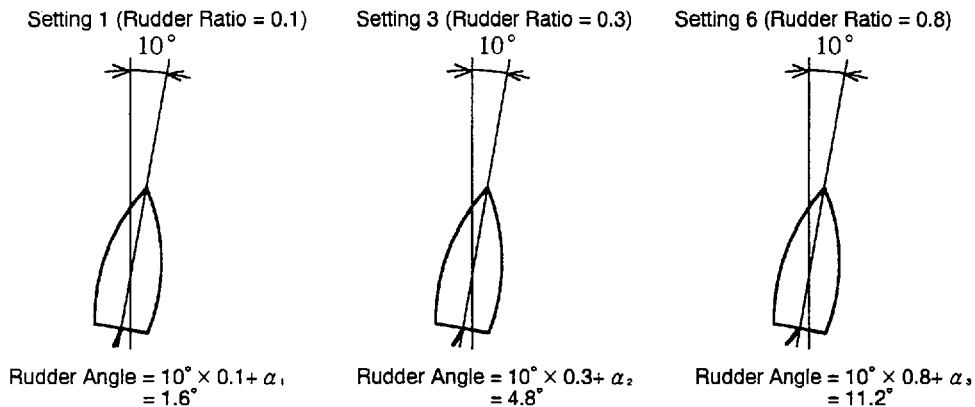

Fig. 6-11 Rudder angle and rudder ratio setting

Increase the setting until over-steering occurs, then reduce it by one. Fig. 6-12 provides general guidelines for setting rudder ratio. (Setting of "4" is commonly used.)

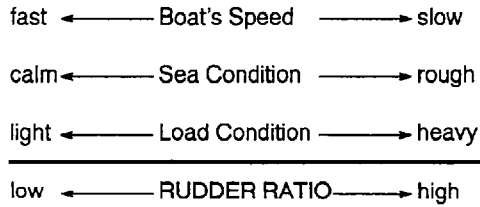





Fig. 6-12 General guidelines for setting rudder ratio

Procedure

— **NOTE :** —
Sea state number should be selected (by the SEA STATE key) before going into the USER'S mode.

1. Hold down  for 2 seconds if you are not already in the USER'S mode.
2. Change the setting with the control dial.
3. Press  to proceed to the next step, or press  to escape.

Weather (Prevent frequent steering in bad weather.)

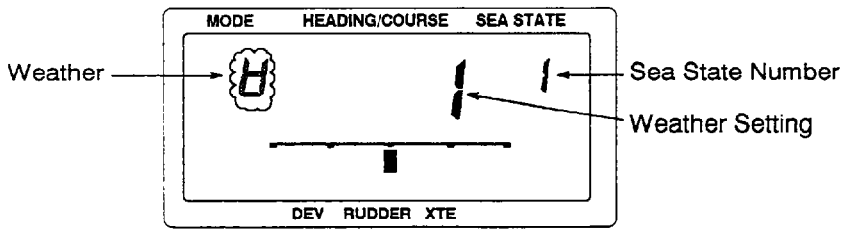

Fig. 6-13 Display for adjusting weather

About weather

When the sea is rough, the boat's heading wanders between port and starboard. If the rudder is driven very often to maintain the set course, the helm mechanism may wear out. To prevent this, the weather adjustment makes the FAP-300 insensitive to minute course deviations.

You may choose a setting (amount of heading change in degrees in which rudder is not driven) among the following ten. Until the course deviation exceeds the selected setting value, steering to correct the heading will not be initiated.

Setting	0	1	2	3	4	5	6	7	8	9
Value	0	± 0.5°	± 1.0°	± 1.5°	± 2.0°	± 2.5°	± 3.0°	± 3.5°	± 4.0°	± 4.5°

The following illustrations show boat's tracklines with weather settings 3 and 7. When 7 is set, for example, the rudder is not driven until the course deviation exceeds 3.5 degrees. Increasing the setting reduces chattering of the rudder, however the boat tends to zigzag.

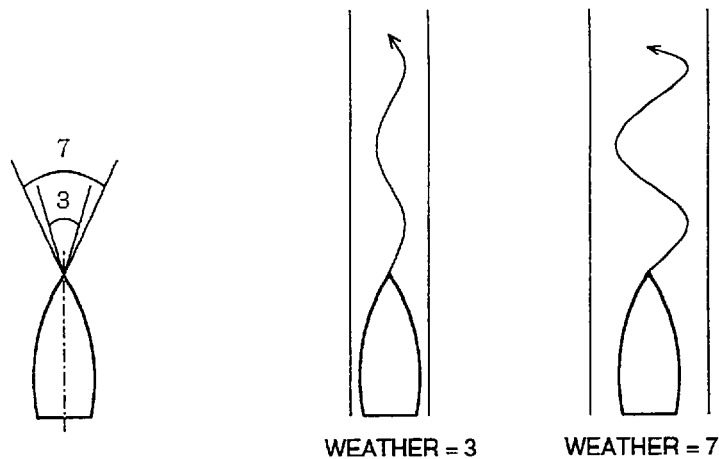





Fig. 6-14 Trackline and weather setting value

When favorable sea conditions exist, a setting of "1" or "2" is appropriate. For rough seas, a higher setting is required.

Procedure

1. Hold down  for 2 seconds if you are not already in the USER'S mode.
2. Press  to select "weather".
3. Change the setting with the course control dial.
4. Press  to proceed to the next step, or press  to escape.

Counter rudder (Prevent excessive turning by inertia when changing course.)

Turned off in default setting.

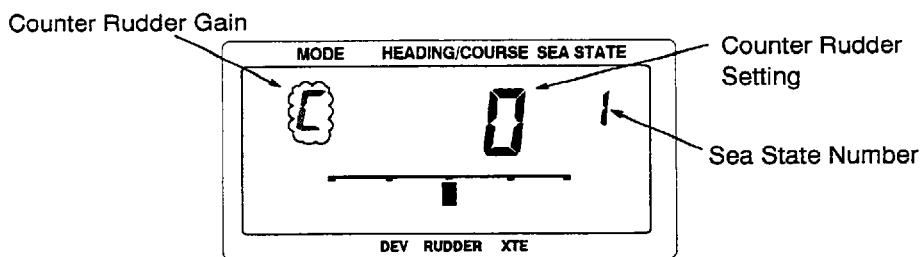

Fig. 6-15 Display for adjusting counter rudder gain

About counter rudder





If the boat is heavily loaded, the heading will turn excessively by inertia, passing the new course. Then, the FAP-300 will steer the rudder to the opposite side and the heading will turn in that direction excessively again... In an extreme case the heading oscillates several times until it finally settles in the new course. An adjustment known as “counter rudder” prevents this kind of oscillation.

Choose a counter rudder setting from “0” to “9”; the higher the setting, the more counter rudder is steered by the FAP-300. (“0” = no counter rudder)

Setting	0	1	2	3	4	5	6	7	8	9
Counter Rudder	None	0.1	0.2	0.3	0.4	0.6	0.8	1.0	1.2	1.5

Counter rudder is usually not required for small boats. When your boat zigzags a lot before settling in the new course, increase the setting.

Procedure

1. Hold down  for 2 seconds if you are not already in the USER'S mode.
2. Press  to select “counter rudder”.
3. Change the setting with the course control dial.
4. Press  to proceed to the next step, or press  to escape.

Automatic trim sensitivity (Adjust the sensitivity for monitoring the boat's trim.)

Turned off in default setting.

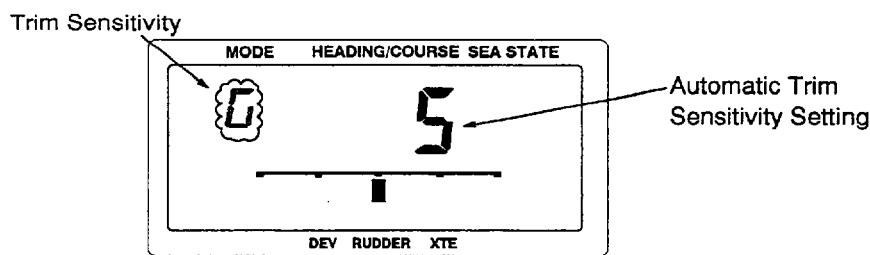

Fig. 6-16 Display for adjusting trim sensitivity

About auto trim sensitivity



The FAP-300 continually monitors the boat's trim in order to keep the compensation value optimum. You may enter a number from "1" to "9". A lower setting is common because boat's trim usually does not change quickly. A large number changes the trim compensation value more frequently. Too high a setting may result in the following problems.

1. Trim compensation is over-affected, resulting that a trim appears in both port and starboard directions alternately. The current trim can be shown on the LCD by enabling the "Performance Indication" mode. More on this later.
2. A boat usually yaws due to waves. If the trim setting is too high, the auto trim-compensation mechanism responds to the yawing, resulting in more serious oscillation of ship's heading.

Choice of setting

Run the boat with setting "0" (Auto trim sensitivity turned off), and measure the period of one cycle of yawing. If the period is two to three seconds, setting "5" will be appropriate. For longer periods, lower settings should be used. If the boat "goes" and "stops" frequently, or if the ship's speed is unstable, it might be better to disable the auto trim sensitivity function by using setting "0".

Procedure

1. Hold down  for 2 seconds if you are not already in the USER'S mode.
2. Press  to select "automatic trim sensitivity".
3. Change the setting with the control dial.
4. Press  to escape.

Performance indication

Introduction

The display can show autopilot performance-related indications. You may want to display them when your boat does not run straightly in the AUTO mode, to determine what item requires adjustment. You can display the following:

- Rudder angle
- Automatic trim compensation
- Rudder deadband

Procedure

1. Turn off the power. Turn on the # 3 segment of the DIP switch S1 on the LCD Board in the Control Unit.

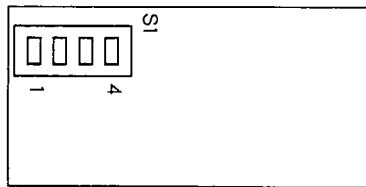



Fig. 6-17 Location of the DIP switch on LCD board

2. Turn on the power.
3. Press the  key for about two seconds. The following display appears.

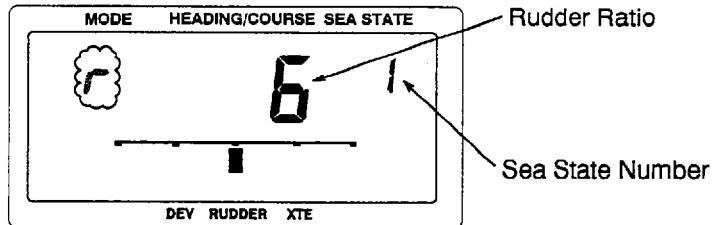



Fig. 6-18 Rudder ratio and sea state number display

4. Press  key several times to display current rudder angle.

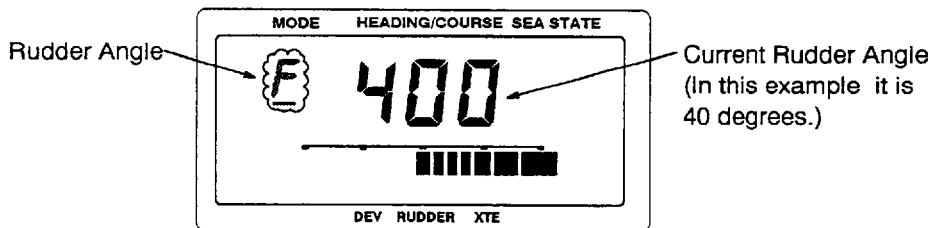



Fig. 6-19 Rudder angle display

5. Press  key once to display automatic trim compensation value.

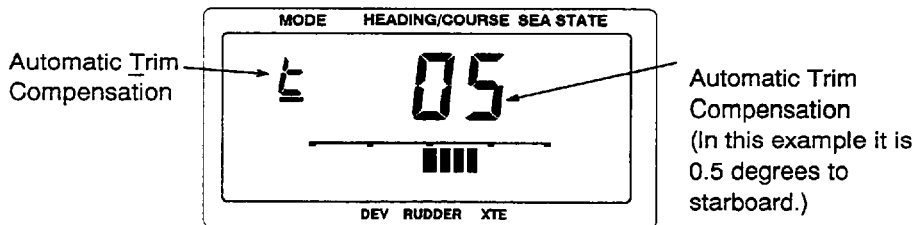



Fig. 6-20 Automatic trim compensation display

The maximum value for the automatic trim compensation is 5 degrees. When the boat does not run straightly with the value "5", register the rudder neutral again or activate the "Net towing AUTO". The maximum trim is 10 degrees less than the rudder angle limitation for REM and DODGE modes.

6. Press  key once to display the rudder deadband.

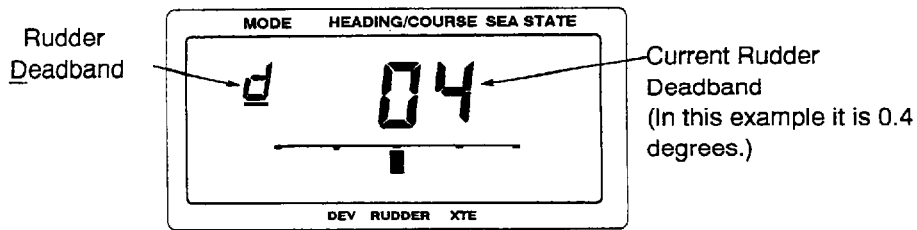

Fig. 6-21 Rudder deadband display

The value should be smaller than 1.5 degrees. The rudder will hunt when the value is larger than 1.5 degrees. Decrease the oil flow to slow the rudder speed to stop the hunting. The FAP-300 can control the hunting when the value is smaller than 1.5 degrees.

7. After observing the indications, turn off the power and then turn off the # 3 segment of the DIP switch S1 on the LCD Board in the Control Unit.

5. Adjusting course changing speed

Once your boat is running straightly in the AUTO mode, adjust the course changing speed.



About course changing speed

The course changing speed is the speed in degrees per second in which the FAP-300 will take to change course.

Danger!

Too high a setting will turn the boat sharply at a course change.

Checking the course changing speed

1. Run the boat straightly in the AUTO mode.
2. Change the course 90 degrees by holding down  or .
3. Release the key.
Observe the course changing speed while the boat returns to the previous course.



You may enter a number from “1” to “7”, which corresponds to the course changing speed of 1 degree/sec to 9 degrees/sec, respectively.

Setting	1	2	3	4	5	6	7
Course Changing Speed (degree/second)	1	2	3	4	5	6	7

A setting of “3” or so is commonly used for a 10 to 15-knot cruising speed. When you feel

the course changing speed is too fast, decrease the setting.

Procedure

1. Hold down  for more than 2 seconds to go into the INITIAL SETTING mode.
2. Press  several times to show the display which follows.

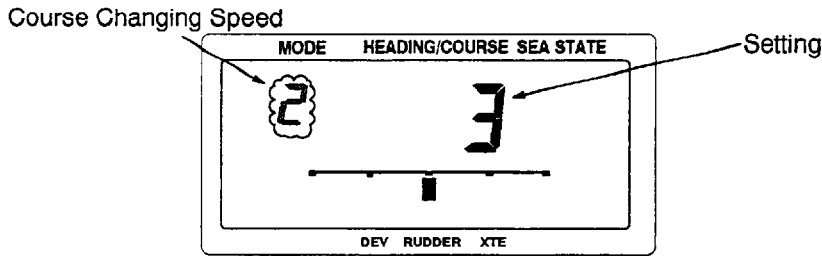



Fig. 6-22 Display for adjusting course changing speed

3. Change the value with the control dial.
4. Press  to escape.

6. Record of steering characteristics

Whenever the steering characteristics are entered or changed, you should record them in the following table. In the event of loss of the settings, reenter them referring to this table.

Item	Default			Settings		
	①	②	③	①	②	③
Rudder Ratio	5	6	7			
Weather	2	4	6			
Counter Rudder	0	0	2			
Dimmer	1					
Automatic Trim Sensitivity	6					
Remote Controller	H					
Course Changing Speed	3					
Rudder Neutral	000					
Rudder Angle Limitation (REM and DODGE modes)	8					

7. Customizing the USER'S mode

Introduction

The USER'S mode contains five items which the user may adjust when necessary: rudder ratio, weather, counter rudder, dimmer and automatic trim sensitivity. In the default setting counter rudder and automatic trim sensitivity are turned off. You may turn them on, or disable other items, as desired.

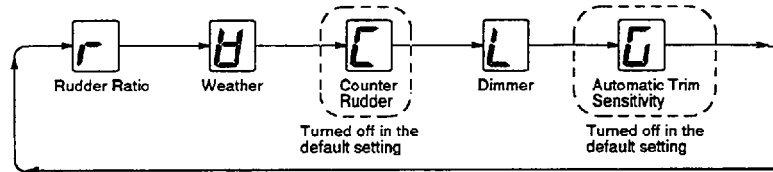





Fig. 6-23 Items in the user's mode

Procedure

1. Hold down  key for more 2 seconds.
2. Press  to select item to turn on or off.
3. Press  to turn item on or off; underline appears beneath item when it is enabled.

NOTE

The underline does not appear beneath the following items to show they are not available for adjustment in the "USER'S mode".

*Remote controller
Course changing speed
Rudder neutral
Rudder angle limitation*

4. Press  to escape.





7. MAINTENANCE

1. Self-test

Introduction

This unit has a self-test facility which checks for proper operation.

Procedure

1. While holding down the  key, turn on the power.
2. Press the  key to select test. Each press changes the test, as well as the display indication, in the sequence shown in Fig. 7-1. Note that you can also select a test by the  key, in which case the sequence is reversed.
3. Selected test is executed and the results appear on the display.
4. Press  to select another test, or press  to escape.

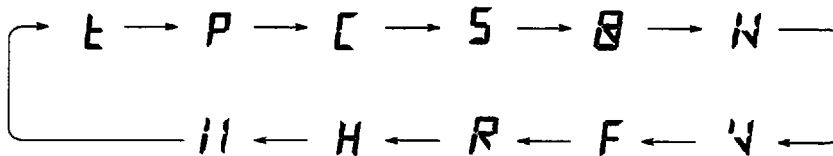

Fig. 7-1 Sequence of self-test

E	ROM and RAM test	V	Input voltage check
P	Program version number	F	Rudder reference feedback signal test
C	Memory all clear	R	Remote controller function test
S	DIP switch setting	H	Rudder speed test
B	LCD segment test	I	Rudder play test
N	Navigation signal test		

ROM and RAM test

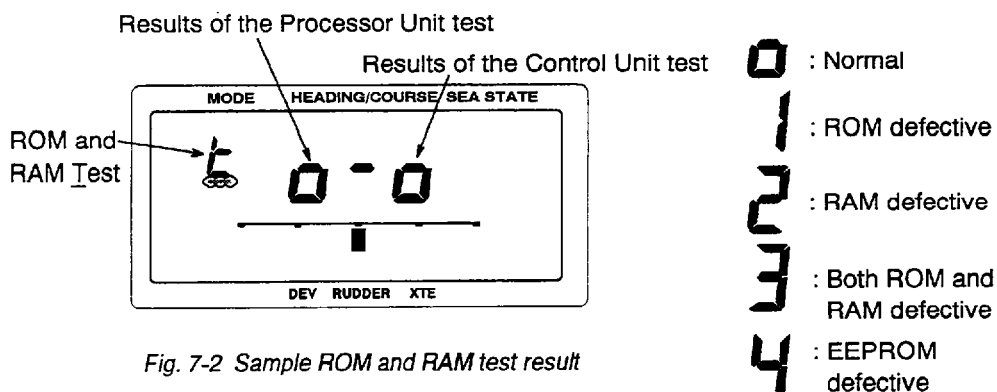

Fig. 7-2 Sample ROM and RAM test result

Program version number

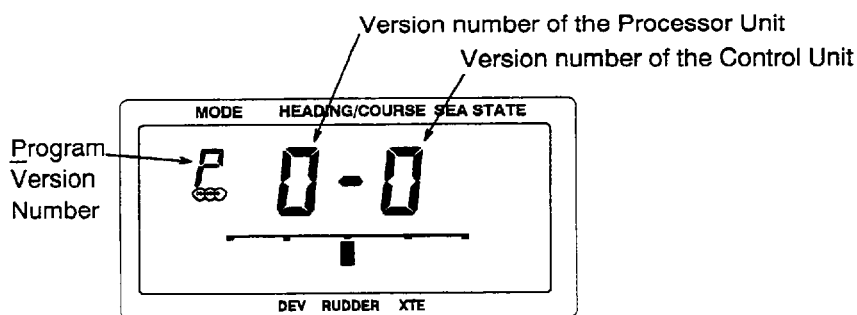



Fig. 7-3 Program version number display

Clearing the memory (Clear when data in EEPROM is lost.)

You can clear all the internal settings memorized in the EEPROM.
 Press  to clear the memory.

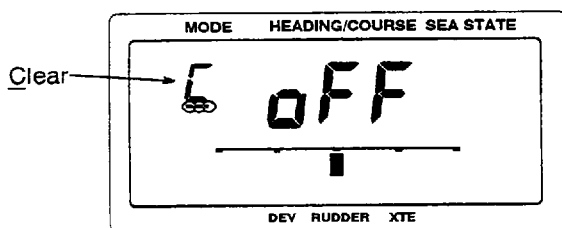

Fig. 7-4 Indication before clearing the memory

- The display shows ON while the memory is being cleared.

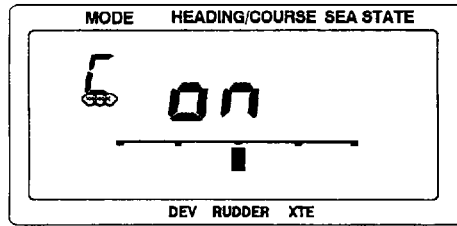

Fig. 7-5 Indication while clearing the memory

- When the memory is cleared the display looks like Fig. 7-6.

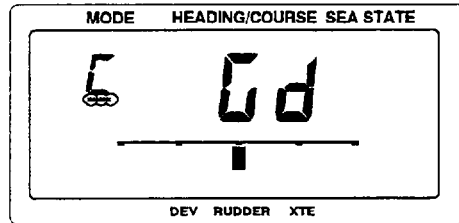

Fig. 7-6 Indication after clearing the memory

- If the memory could not be cleared the display looks like Fig. 7-7. In this case the EEPROM may be defective.

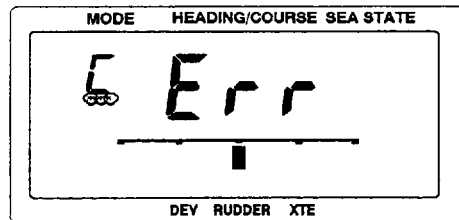

Fig. 7-7 Indication when memory could not be cleared

DIP switch settings

The results are shown in hexadecimal notation. “OFF” is “0” and “ON” is “1”.

Example

Segment 5, 6, 7 and 8 are OFF, OFF, ON and ON, respectively. This is 0, 0, 1, 1 so the presentation will be “C”.

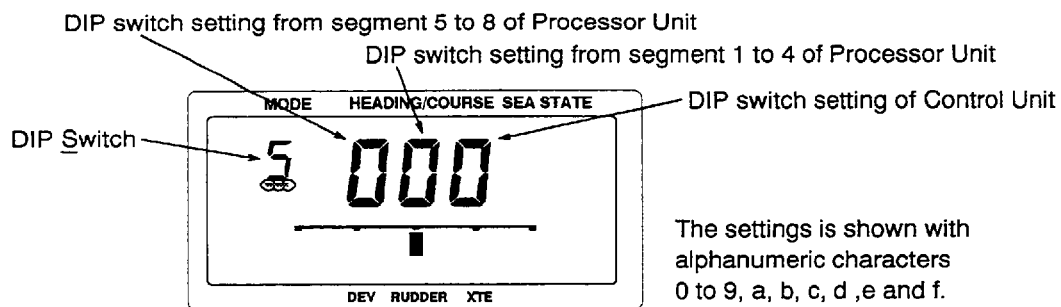



Fig. 7-8 Sample DIP switch setting for each unit

LCD segment test

Press  to start the test. The LCD segments turn on one by one in following sequence:

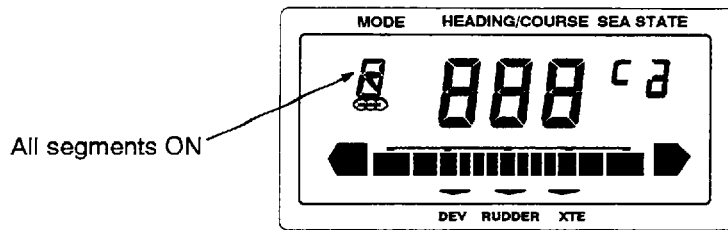

Fig. 7-9 First presentation in LCD segment test

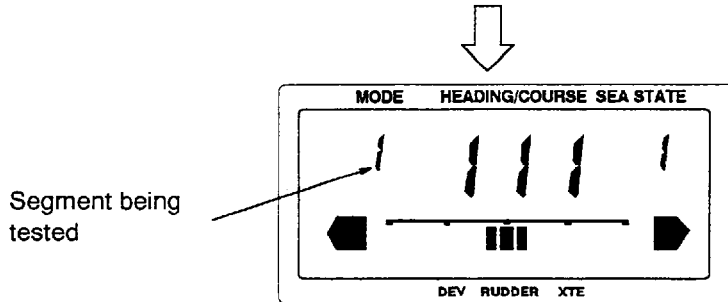

Fig. 7-10 Second presentation in LCD segment test

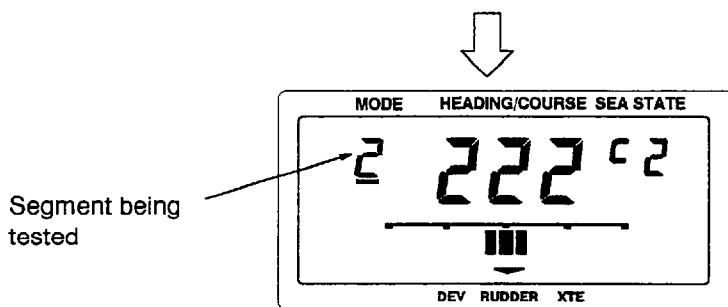

Fig. 7-11 Third presentation in LCD segment test

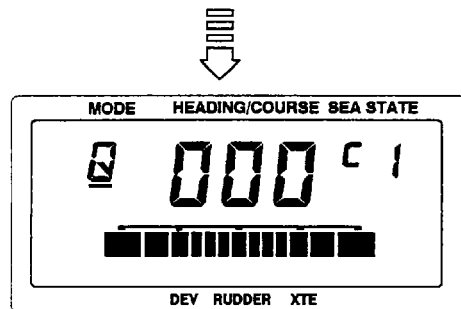

Fig. 7-12 Final presentation in LCD segment test

Navigation signal test

Navigation signals such as waypoint data, cross-track error data, speed data and arrival data are required to control the FAP-300 in the NAV mode. You can confirm that they are being input.

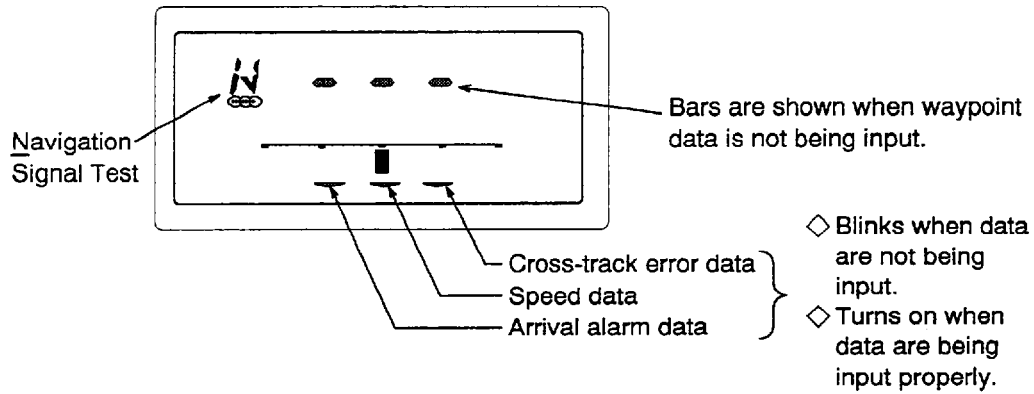

Fig. 7-13 Indication when no navigation data are input

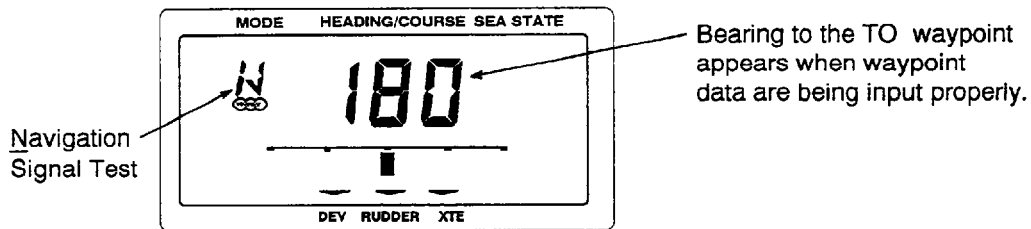

Fig. 7-14 Indication when all navigation data are being input

Input voltage presentation

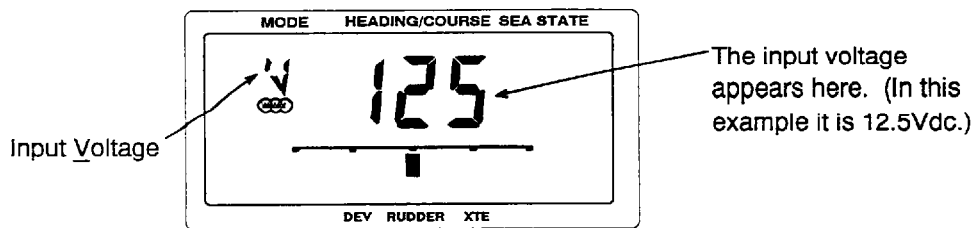

Fig. 7-15 Input voltage display

Rudder reference unit feedback signal test

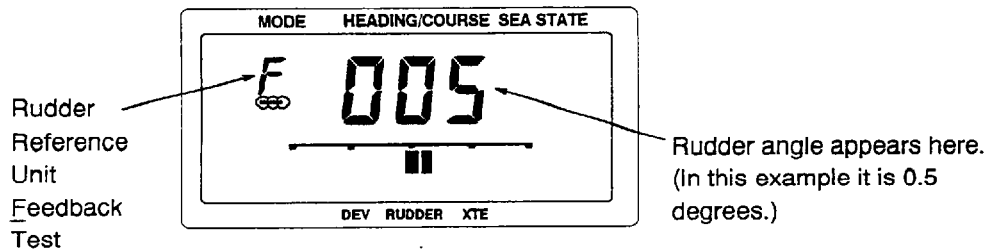

Fig. 7-16 Indication of rudder reference unit signal

Remote controller function test

The LCD shows the data sent from the FAP-5551 (Dial-type remote controller). Other types of remote controllers cannot be tested.

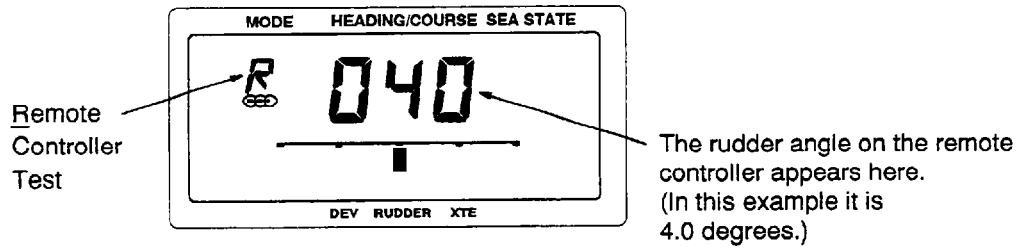

Fig. 7-17 Indication for FU (Follow-Up)- type remote controller

The LCD shows three dashes when the remote controller is turned off.

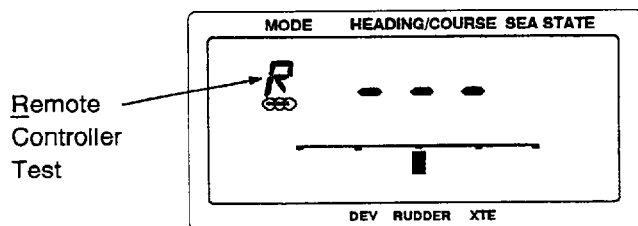



Fig. 7-18 Indication when the remote controller is turned off

Rudder speed test

Set the rudder angle limitation before executing the test.

— **WARNING** —

This test drives the rudder from hard port to hard starboard to calculate actual rudder speed. Therefore, do not execute the test when the boat is running.

Press  to start the test.

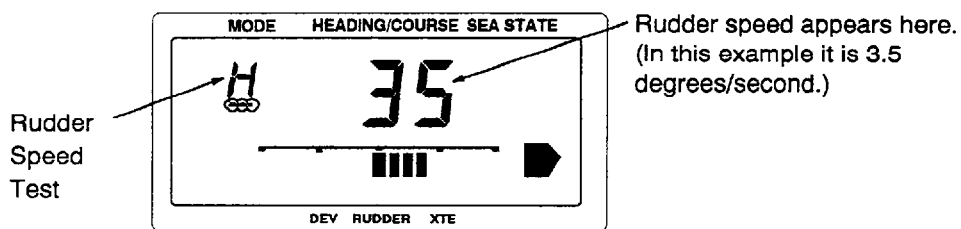

Fig. 7-19 Indication of rudder speed

While calculating rudder speed, the display looks like Fig. 7-20.

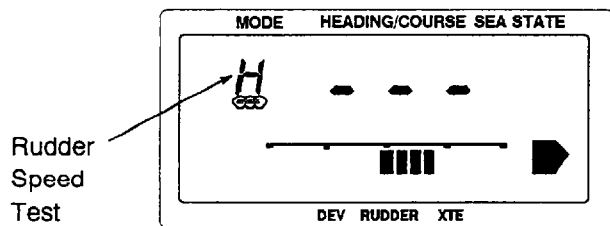

Fig. 7-20 Indication while calculating rudder speed

Rudder play test

The CPU calculates the rudder play while testing the rudder speed. Execute the rudder speed test and then the rudder play test.

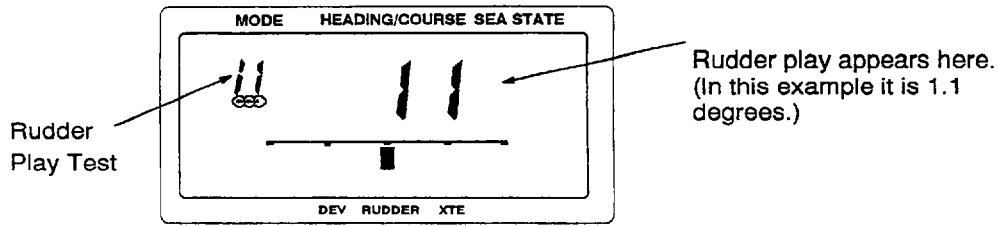

Fig. 7-21 Indication of rudder play

While calculating rudder play, the display looks like Fig. 7-22.

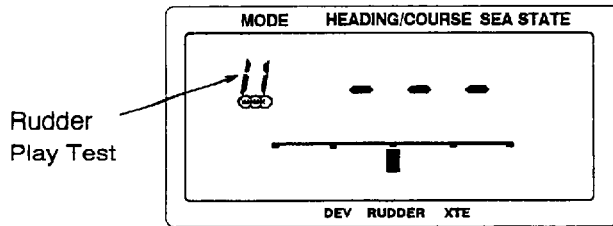

Fig. 7-22 Indication while calculating rudder play

2. Checking LED status

The LEDs in the Processor Unit light or flicker according to autopilot operation.

LED Number	Status
CR12	Flickers every 0.5 seconds.
CR23	Lights while turning the rudder left.
CR24	Lights while turning the rudder right.
CR26	Lights while driving a DC motor pump.

Equipment List

Standard Supply

Name	Type	Qty	Wt. (kg)	Remarks
Control Unit	FAP-3001	1	0.6	
Processor Unit	FAP-3002	1	0.8	
Rudder Reference Unit	FAP-6110	1	0.2	
Accessories	FP64-00800	1 set		
Spare Parts	SP64-01000	1 set		
Installation Material	CP64-01500	1 set		



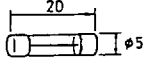

Optional Supply

Name	Type	Code No.	Qty	Remarks
FU (Follow-up) Remote Controller	FAP-5551E	000-090-224		Dial type
NFU (Non-follow-up) Remote Controller	FAP-6211E	000-090-235		Button type
NFU Remote Controller	FAP-6221E	000-090-239		Lever type
Dodge Remote Controller	FAP-6231E	000-090-251		Dodge type
Distributor	FAP-6800	000-090-242		
Rudder Telltale	FAP-6501E	000-090-240		
Valve Unit (w/8m cable and crimp-on lugs)	SPF-1SVF-12/E	000-090-130		12Vdc
	SPF-1SVF-24/E	000-090-131		24Vdc
Flush Mounting Materials	OP20-18	000-040-721		F type
	OP20-17	000-040-720		S type
Hanger	OP64-2	009-004-030		for FAP-5551
Flush Mounting Materials	OP64-4	009-005-790		F type for FAP-6221/6501
	OP64-5	009-005-800		S type for FAP-6501
Signal Cables	MJ-A6SPF 0007-100	000-125-237		To connect Navaid or rudder telltale unit
	MJ-A6SPF 0008-200	000-126-661		20m cable for rudder reference unit
	MJ-A10SPF 0001-120	000-126-660		12m cable for remote controller
	MJ-A10SPF 0002-100	000-126-659		10m cable for control unit
	20S0093	000-117-603		To connect AD-100

FURUNO

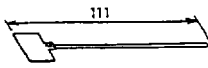
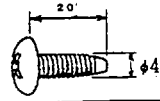

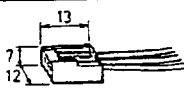
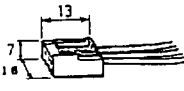
		CODE No.	000-090-248	BOX No. _____ P _____		
		TYPE	SP64-01000			
SHIP No.	SPARE PARTS LIST FOR			U S E		
	FAP-300 オートパイロット AUTO PILOT					
ITEM No.	NAME OF PART	O U T L I N E	DWG. No. OR TYPE No.	QUANTITY		REMARKS/CODE No.
				WORKING	SPARE	
				PER SET	PER VES.	
1	ミゼットヒューズ FUSE		FGMB 5A AC125V			3 000-112-785

FURUNO

		CODE NO	000-090-254	64AQ-X-9401	
		TYPE	CP64-01500		
工事材料表 INSTALLATION MATERIALS		FAP-300 オートパイロット AUTO PILOT			
番号 No	名称 NAME	略 図 OUTLINE	型名 / 規格 DESCRIPTIONS	数量 Q'TY	用途 / 備考 REMARKS
1	ケーブルホルダ CABLE CLAMP		PLF1M-M CODE NO 000-116-921	5	
2	+トラスタップコネクタ +TAPPING SCREW		M4 x 20 SUS304 CODE NO 000-805-687	8	
3	ミカキ平座金 FLAT WASHER		M4 SUS304 CODE NO 000-864-126	8	
4	V H コネクタ CONNECTOR		64-103(3P) CODE NO 009-013-100	1	
5	V H コネクタ CONNECTOR		64-104(4P) CODE NO 009-013-200	1	
6	電源ケーブル組品 POWER CABLE ASSEMBLY		P64-1-5 CODE NO 009-012-530	1	
7	ケーブル組品 CABLE ASSY.		MJ-A10SPF0002-050 CODE NO 000-131-411	1	

FURUNO

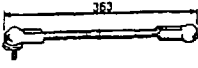
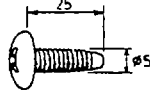
CODE NO	000-012-450	64AQ-X-9402-1
TYPE	CP64-01700	

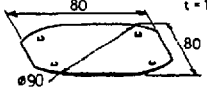
工事材料表 INSTALLATION MATERIALS		FAP-6110 追従発信器 RUDDER REFERENCE UNIT			
番号 No	名称 NAME	略図 OUTLINE	型名 / 規格 DESCRIPTIONS	数量 Q'TY	用途 / 備考 REMARKS
1	連結棒組立品 CONNECTING ROD ASSY.		CP64-01710 CODE NO 009-013-210	1	
2	+トラスタップ"ソク"ネジ" +TAPPING SCREW		M4 x 20 SUS304 CODE NO 000-805-687	4	
3	ミカキ平座金 FLAT WASHER		M4 SUS304 CODE NO 000-864-126	4	
4	カスケット(3) GASKET		64-019-5009-0 CODE NO 100-205-550	1	

FURUNO

CODE NO	000-090-249	64AQ-X-9501
TYPE	FP64-00800	

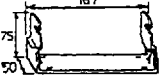
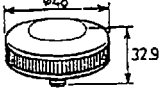
付属品表 ACCESSORIES		FAP-300 オートパイロット AUTO PILOT			
番号 No	名称 NAME	略図 OUTLINE	型名 / 規格 DESCRIPTIONS	数量 Q'TY	用途 / 備考 REMARKS
1	ハンガー HANGER		20-007-2301-1 CODE NO 100-183-181	1	
2	ノブボルト組品 KNOB BOLT ASSY.		20-007-2302-1 CODE NO 100-173-271	2	

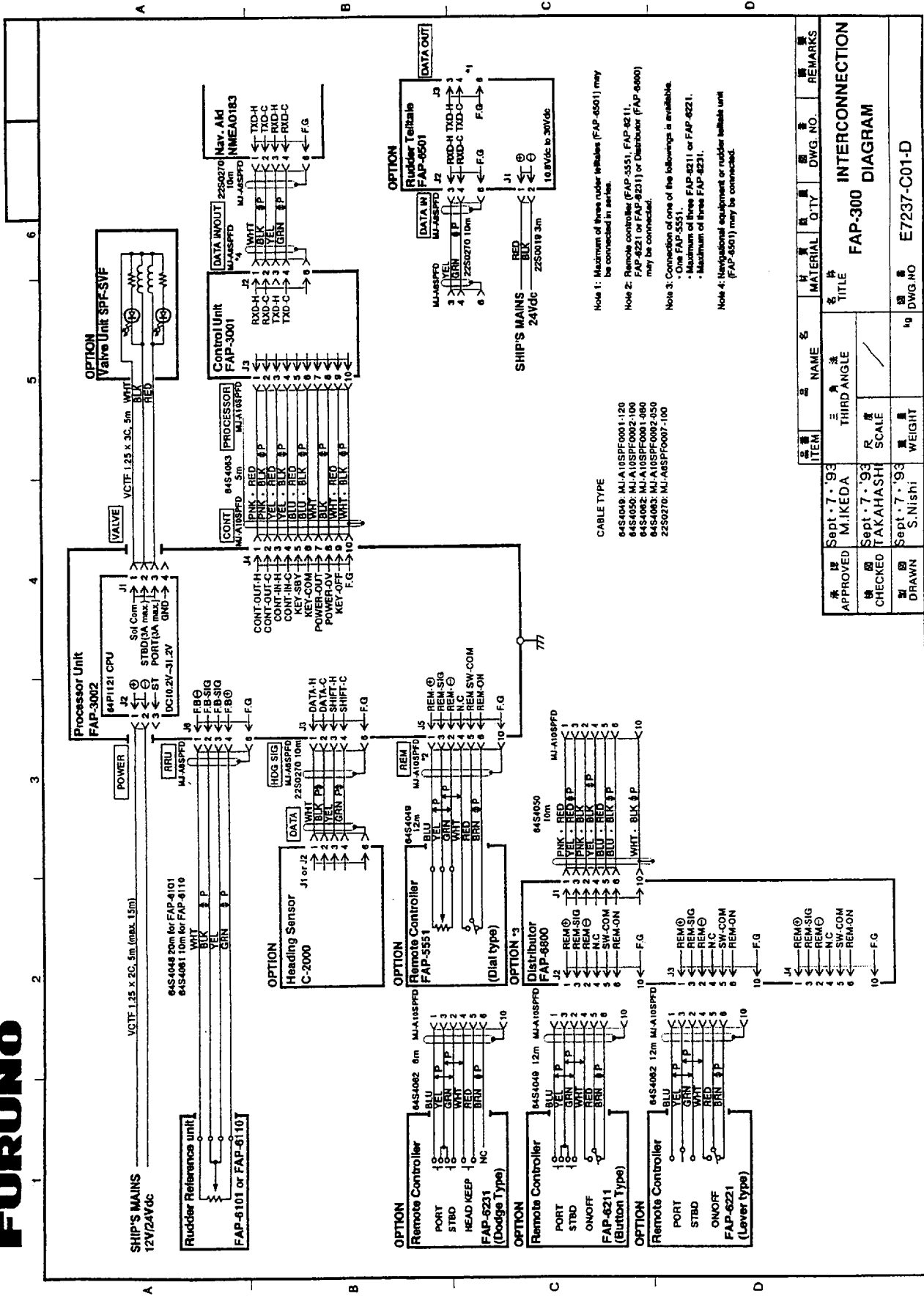

CABLE TYPE
 64S4049: MJ-A10SPF0001-120
 64S4050: MJ-A10SPF0002-100
 64S4062: MJ-A10SPF0001-080
 64S4063: MJ-A10SPF0002-050
 22S0270: MJ-ASFP0007-100

Note 1: Maximum of three rudder teletails (FAP-6501) may be connected in series.
Note 2: Remote controller (FAP-6211, FAP-6221, FAP-6231) or Distributor (FAP-6800) may be connected.
Note 3: Connection of one of the followings is available.
 - One FAP-5551.
 - Maximum of three FAP-6211 or FAP-6221.
 - Maximum of three FAP-6231.
Note 4: Miscellaneous equipment or rudder teletail unit (FAP-6501) may be connected.

承認 APPROVED	検査 CHECKED	製図 DRAWN	品名 ITEM	名称 NAME	数量 QTY	材質 MATERIAL	図番 DWG. NO.	備考 REMARKS
Sept. 7. '93 M.IKEDA	Sept. 7. '93 TAKAHASHI	Sept. 7. '93 S.Nishi	品名	名称	数量	材質	図番	備考
			INTERCONNECTION DIAGRAM					
			FAP-300					
			THIRD ANGLE					
			SCALE					
			WEIGHT					
			DWG. NO. E7237-C01-D					

FURUNO ELECTRIC CO., LTD.

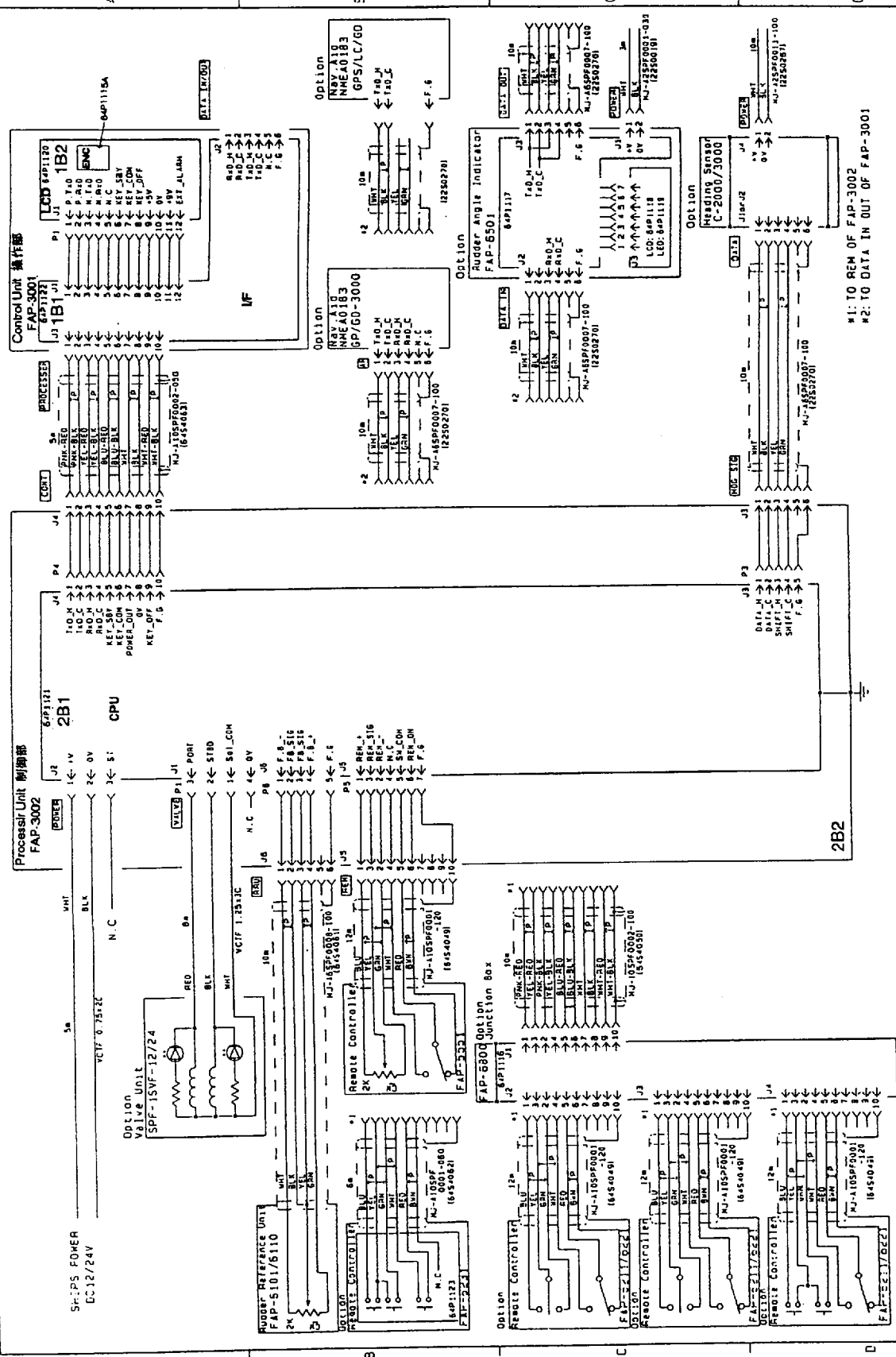

REV NO	MARK	DATE	SENSE	REV-3

REMARKS	
TYPE	FAP-300
NAME	オートパイロット
NAME	AUTOPILLOT
APPLICABLE TO:	
MODEL	
NO.	

#1: REM OF FAP-3002
 #2: TO DATA IN OUT OF FAP-3001

A
B
C
D

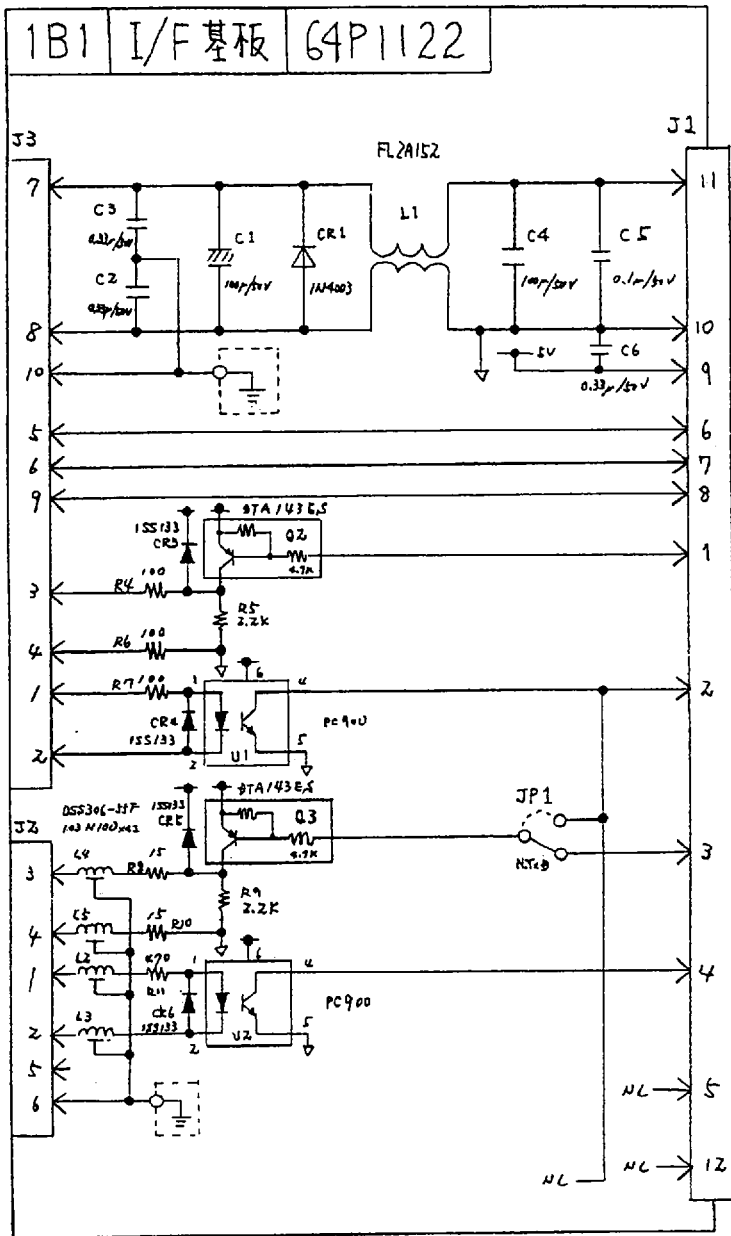

FAP-3001

承認 APPROVED	Sept. 7 '93 M. Ikeda	三角法 THIRD ANGLE		名称 TITLE	I/F 基板 I/F board
検図 CHECKED	Sept. 7 '93 TAKAHASHI	尺度 SCALE	/	64P1122	I/F board
製図 DRAWN	Sept. 7 '93 S. Nishi	重量 WEIGHT	kg	図番 DWG.NO	C7237-K03-B

FURUNO ELECTRIC CO., LTD.

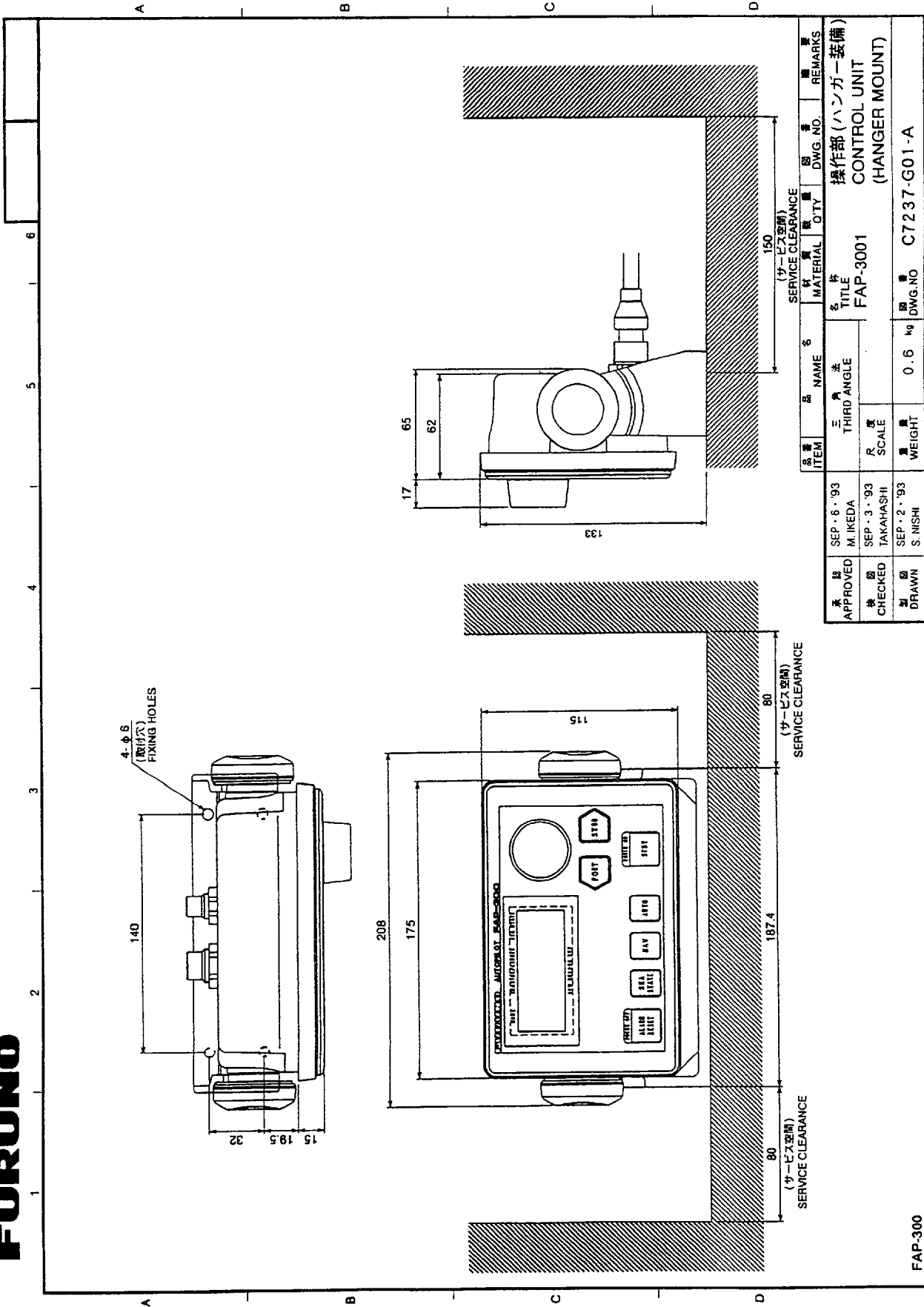

APPROVED		SEP・6・93		M. IKEDA		MATERIAL		SERVICE CLEARANCE		REMARKS	
CHECKED		SEP・3・93		TAKAHASHI		QTY		TITLE		CONTROL UNIT (HANGER MOUNT)	
DRAWN		SEP・2・93		S. NISHI		WEIGHT		DWG.NO		C7237-G01-A	
品名	品名	品名	品名	品名	品名	品名	品名	品名	品名	品名	品名
ITEM	ITEM	ITEM	ITEM	ITEM	ITEM	ITEM	ITEM	ITEM	ITEM	ITEM	ITEM
FAP-300		0.6 kg		C7237-G01-A		FAP-3001		CONTROL UNIT (HANGER MOUNT)		OPERATION UNIT (HANGER MOUNT)	

FAP-300

FURUNO ELECTRIC CO., LTD.

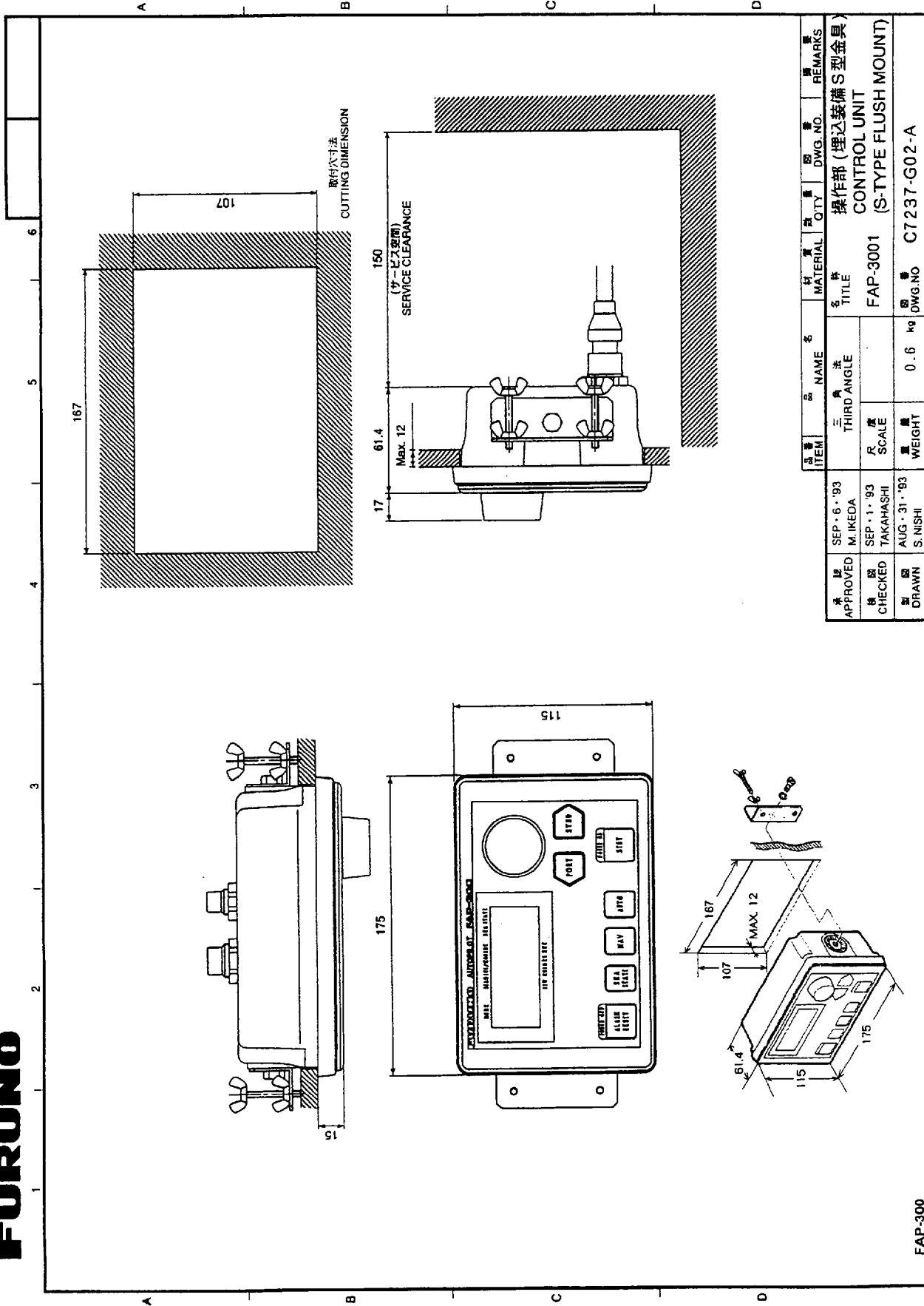

FURUNO ELECTRIC CO., LTD.

FAP-300

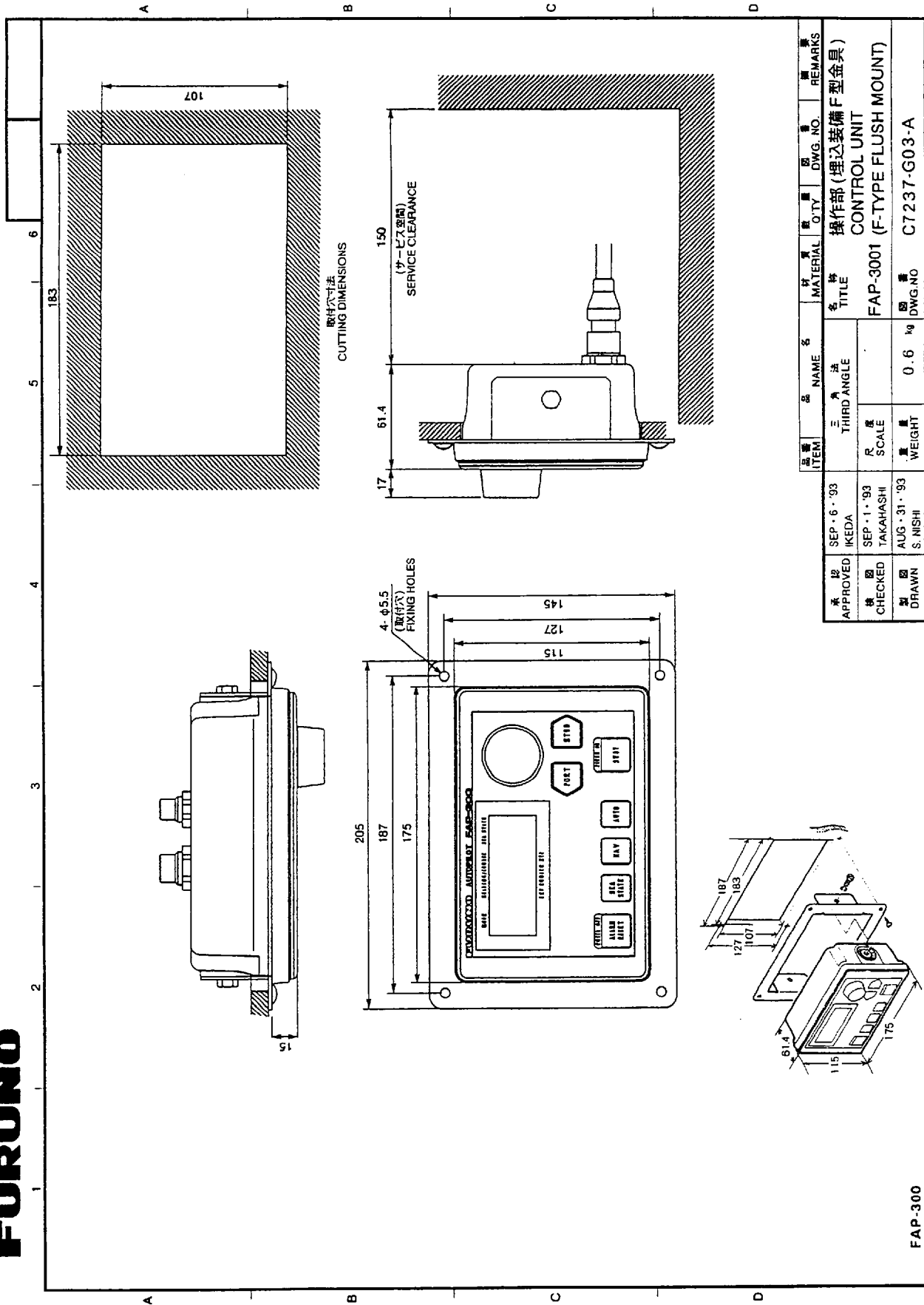

承認 APPROVED	設計 DESIGNED	検査 CHECKED	製図 DRAWN	承認 DATE	承認 S. NISHI	承認 AUG. 31. '93	承認 SEP. 1. '93	承認 IKEDA	承認 SEP. 6. '93	承認 KEDA	
品名 ITEM NAME		品名 ITEM NAME		数量 QTY		材料 MATERIAL		数量 QTY		備註 REMARKS	
第三角 THIRD ANGLE		度 SCALE		重量 WEIGHT		DWG. NO		C7237-G03-A		操作部(埋込装備F型金具) CONTROL UNIT FAP-3001 (F-TYPE FLUSH MOUNT)	

FAP-300

FURUNO ELECTRIC CO., LTD.

A

B

C

D

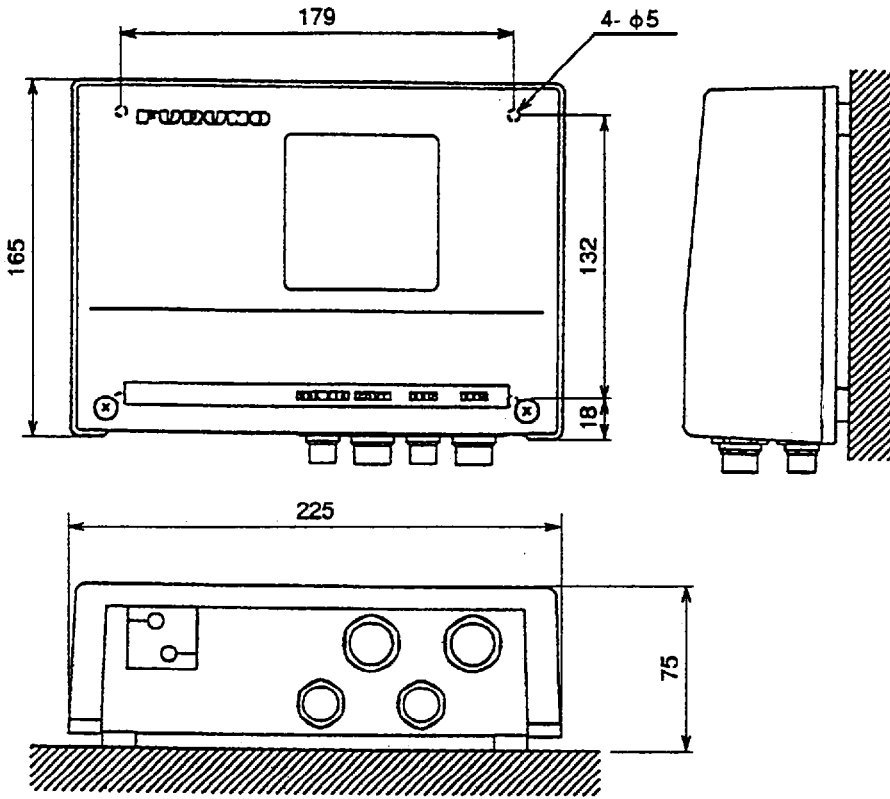

FAP-300		品番 ITEM	品名 NAME	材質 MATERIAL	数量 Q'TY	図番 DWG. NO.	摘要 REMARKS
承認 APPROVED	SEP・6・'93 M. IKEDA	三角法 THIRD ANGLE		名称 TITLE	制御部		
検図 CHECKED	SEP・1・'93 TAKAHASHI	尺度 SCALE		FAP-3002 PROCESSOR UNIT			
製図 DRAWN	AUG・26・'93 S. NISHI	重量 WEIGHT	0.8 kg	図番 DWG. NO	C7237-G04-A		

FURUNO

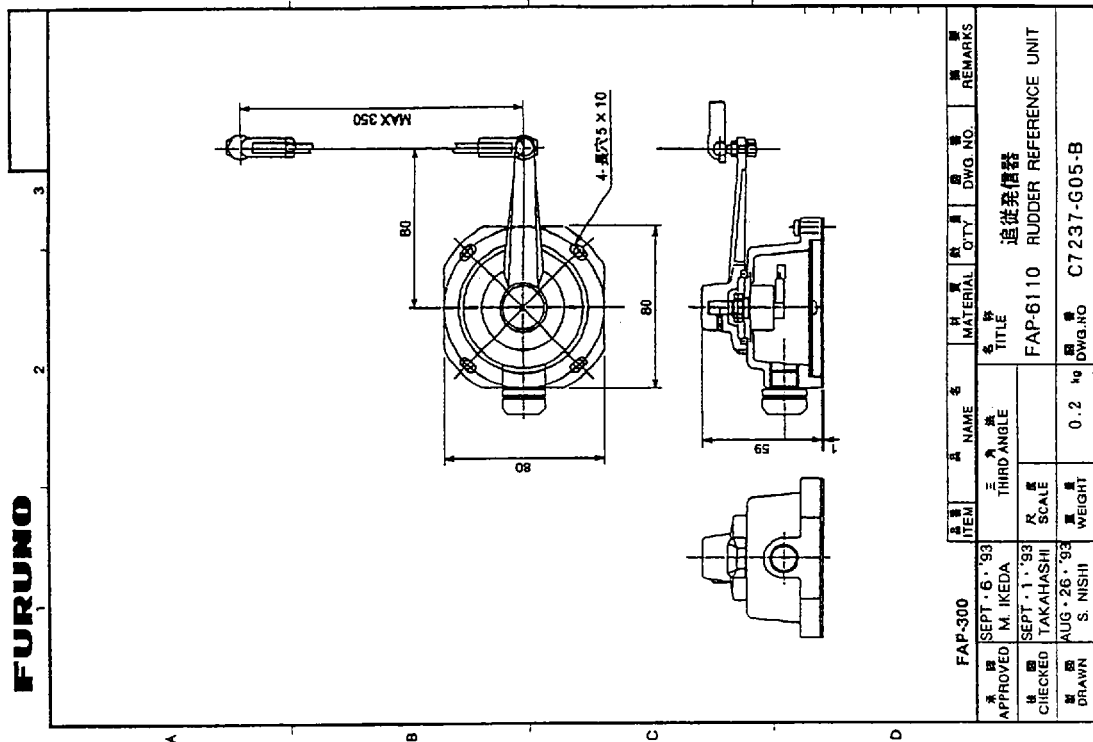

FAP-300		品名	追従発信器	数量	1	材料		数量	1	図番	C7237-G05-B	備註	
承認	SEPT. 6. '93	承認者	M. IKEDA	承認日		品名	FAP-6110	数量	1	図番	C7237-G05-B	備註	
検閲	SEPT. 1. '93	検閲者	TAKAHASHI	検閲日		品名	追従発信器	数量	1	図番	C7237-G05-B	備註	
描画	AUG. 26. '93	描画者	S. NISHI	描画日		品名	RUDDER REFERENCE UNIT	数量	1	図番	C7237-G05-B	備註	
承認		承認者		承認日		品名		数量		図番		備註	
検閲		検閲者		検閲日		品名		数量		図番		備註	
描画		描画者		描画日		品名		数量		図番		備註	

FURUNO ELECTRIC CO., LTD.

FURUNO

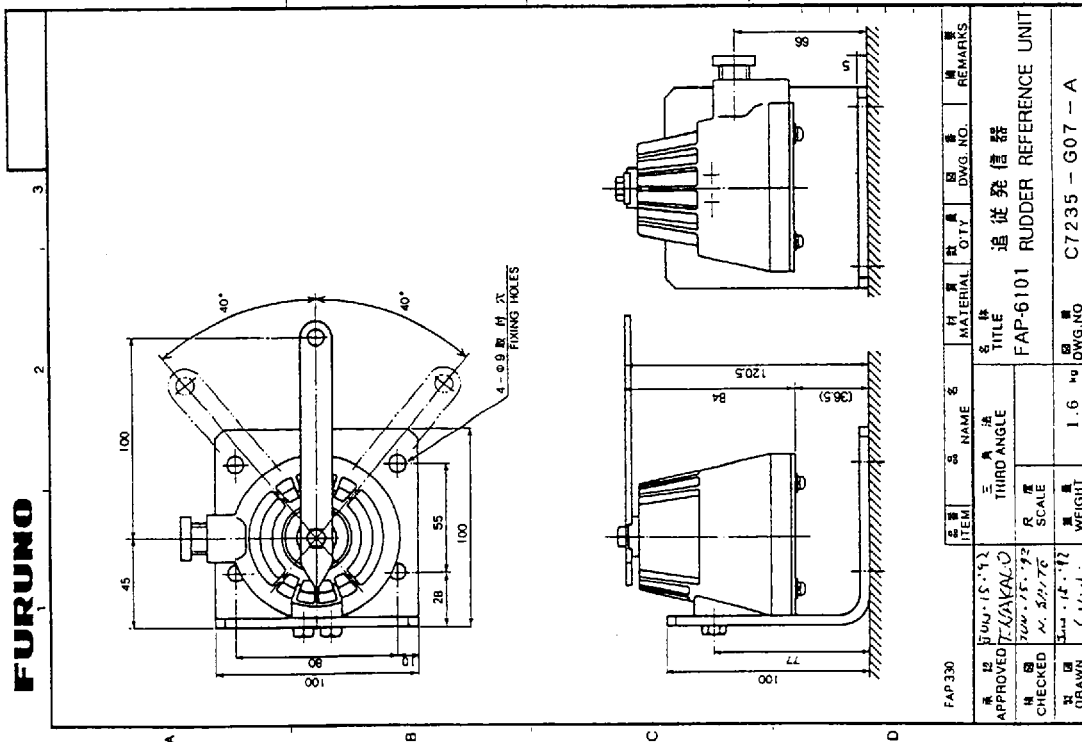

FAP-330		品名	追従発信器	数量	1	材料		数量	1	図番	C7235-G07-A	備註	
承認	7.15.92	承認者	M. IKEDA	承認日		品名	FAP-6101	数量	1	図番	C7235-G07-A	備註	
検閲	7.15.92	検閲者	M. S. NISHI	検閲日		品名	追従発信器	数量	1	図番	C7235-G07-A	備註	
描画	7.15.92	描画者	S. NISHI	描画日		品名	RUDDER REFERENCE UNIT	数量	1	図番	C7235-G07-A	備註	
承認		承認者		承認日		品名		数量		図番		備註	
検閲		検閲者		検閲日		品名		数量		図番		備註	
描画		描画者		描画日		品名		数量		図番		備註	

FURUNO ELECTRIC CO., LTD.

FURUNO

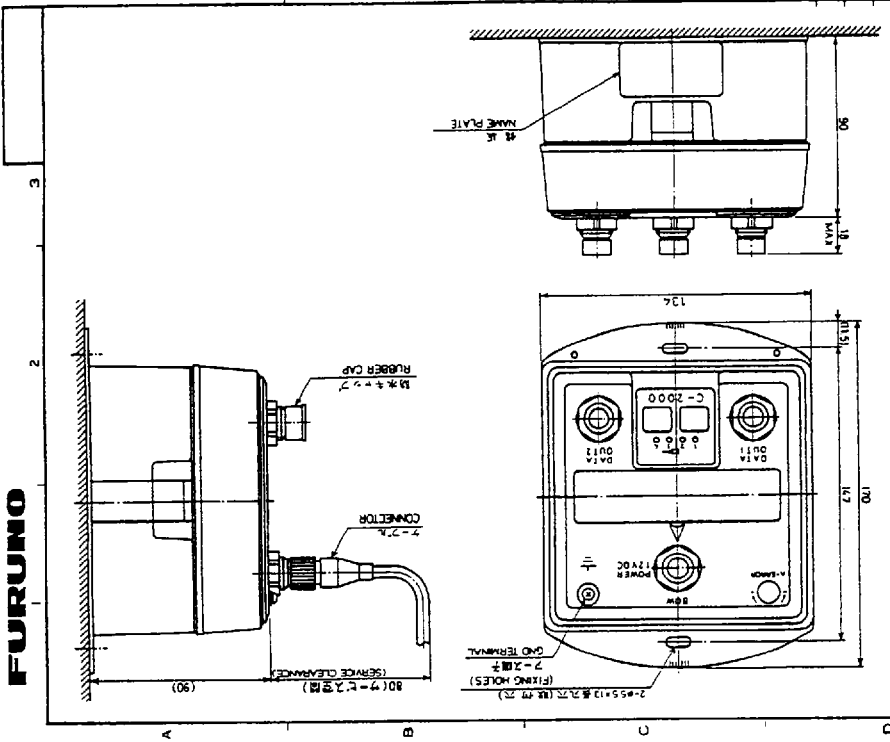

品名 MARK-6-13.2 APPROVED T.J./AKAGI/D	品名 HEADING SENSOR	数量 C-2000	重量 0.5 kg	図番 C7233-G01-A	備考
検出 T.J./AKAGI/D	検出 R SCALE	検出 R SCALE	検出 WEIGHT	検出 DWG. NO.	検出 REMARKS
検出 T.J./AKAGI/D	検出 R SCALE	検出 R SCALE	検出 WEIGHT	検出 DWG. NO.	検出 REMARKS
検出 T.J./AKAGI/D	検出 R SCALE	検出 R SCALE	検出 WEIGHT	検出 DWG. NO.	検出 REMARKS

FURUNO ELECTRIC CO., LTD.

FURUNO

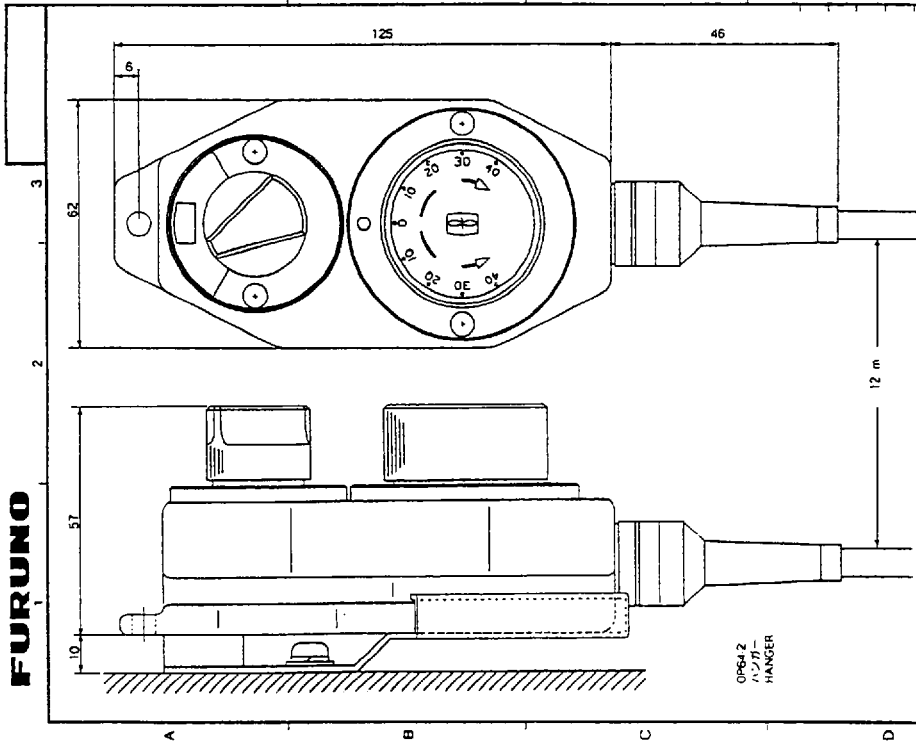

品名 FAP-5551 APPROVED T.J./AKAGI/D	品名 REMOTE CONTROLLER	数量 FAP-5551	重量 0.5 kg	図番 C7235-G04-A	備考
検出 T.J./AKAGI/D	検出 R SCALE	検出 R SCALE	検出 WEIGHT	検出 DWG. NO.	検出 REMARKS
検出 T.J./AKAGI/D	検出 R SCALE	検出 R SCALE	検出 WEIGHT	検出 DWG. NO.	検出 REMARKS
検出 T.J./AKAGI/D	検出 R SCALE	検出 R SCALE	検出 WEIGHT	検出 DWG. NO.	検出 REMARKS

FURUNO ELECTRIC CO., LTD.

FURUNO

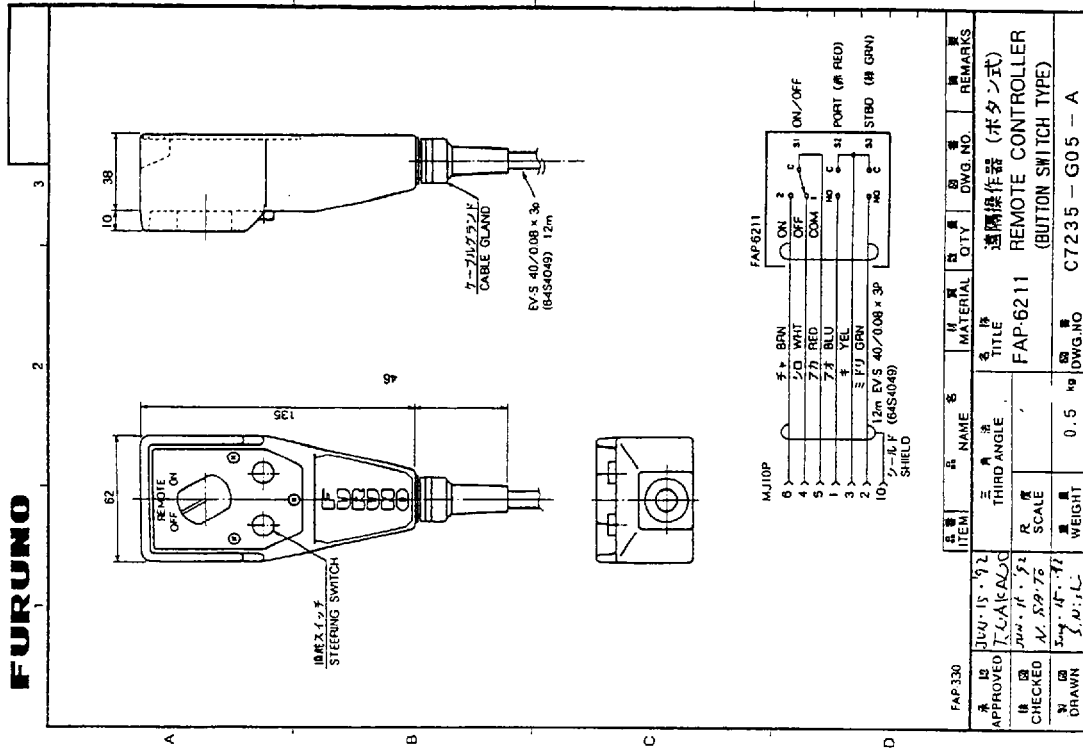

品番 ITEM	品名 NAME	材質 MATERIAL	数量 QTY	図番 DWG. NO.	備考 REMARKS
FAP-330	名称 FAP-6211				
承認 APPROVED	承認者 JUN. 15. 92 T. TAKAKA	承認日 2002. 11. 22	承認場所 N. S. P. 70	承認者 S. N. I.	備考 FAP-6211 遠隔操作器 (ボタン式) (BUTTON SWITCH TYPE)
検出 CHECKED	検出者 S. N. I.	検出日 2002. 11. 22	検出場所 N. S. P. 70	検出者 S. N. I.	備考
製図 DRAWN	製図者 S. N. I.	製図日 2002. 11. 22	製図場所 N. S. P. 70	製図者 S. N. I.	備考
	重量 WEIGHT	0.5 kg			
	図番 DWG. NO.	C7235 - G05 - A			

FURUNO ELECTRIC CO., LTD.

FURUNO

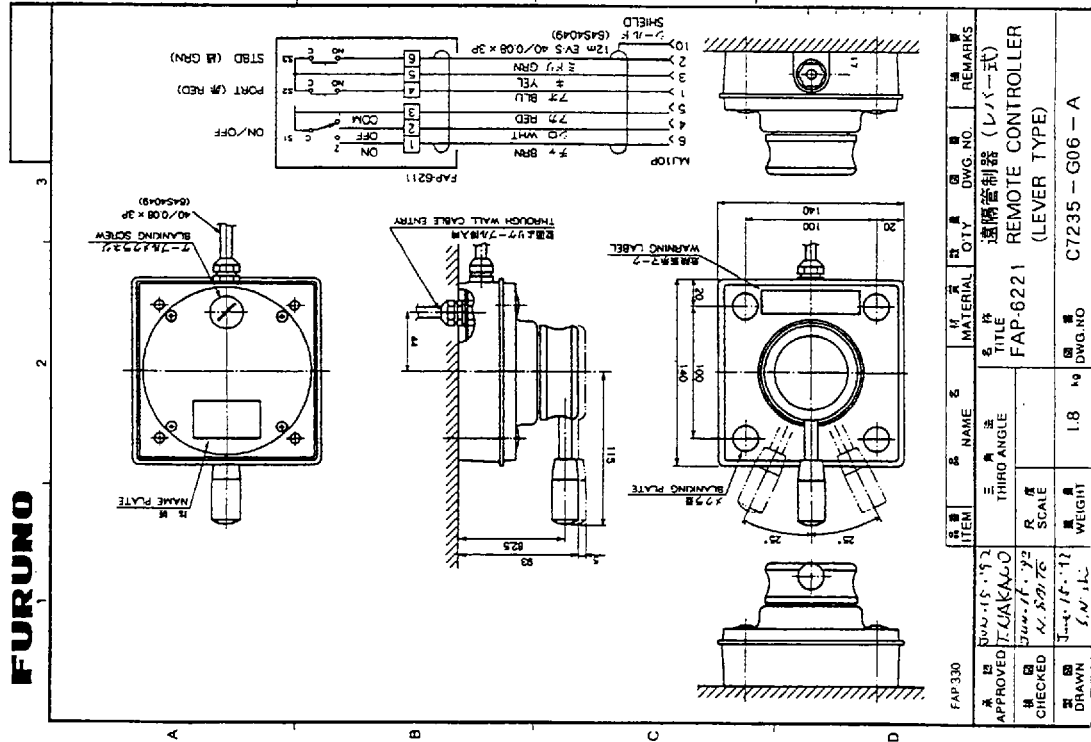

品番 ITEM	品名 NAME	材質 MATERIAL	数量 QTY	図番 DWG. NO.	備考 REMARKS
FAP-330	名称 FAP-6221				
承認 APPROVED	承認者 JUN. 15. 92 T. TAKAKA	承認日 2002. 11. 22	承認場所 N. S. P. 70	承認者 S. N. I.	備考 FAP-6221 遠隔操作器 (レバー式) (LEVER TYPE)
検出 CHECKED	検出者 S. N. I.	検出日 2002. 11. 22	検出場所 N. S. P. 70	検出者 S. N. I.	備考
製図 DRAWN	製図者 S. N. I.	製図日 2002. 11. 22	製図場所 N. S. P. 70	製図者 S. N. I.	備考
	重量 WEIGHT	1.8 kg			
	図番 DWG. NO.	C7235 - G06 - A			

FURUNO ELECTRIC CO., LTD.

FURUNO

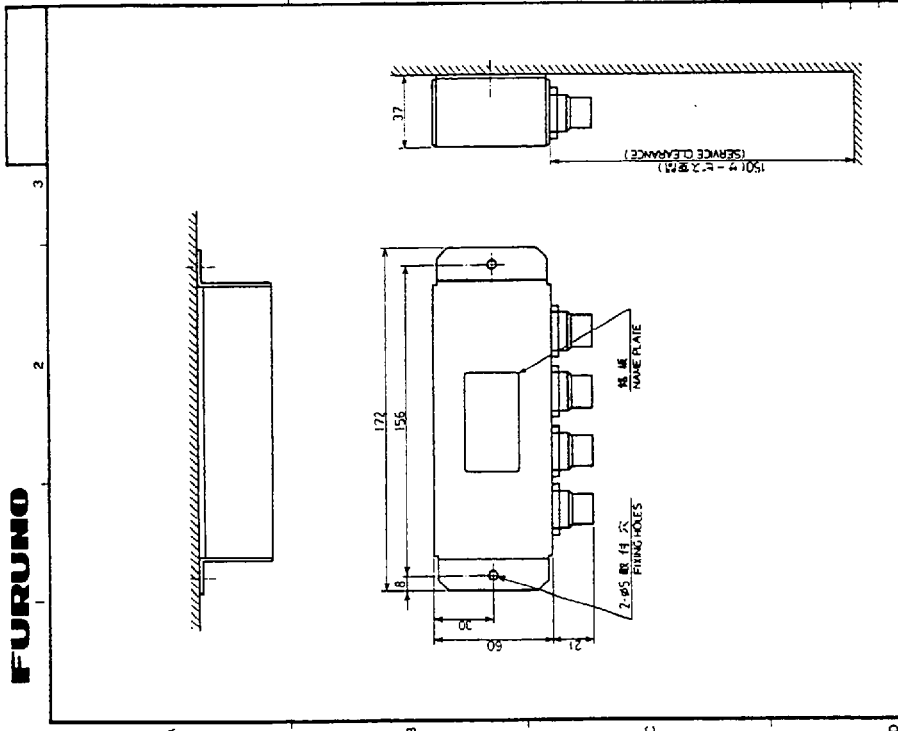

品名 ITEM	名称 NAME	数量 QTY	材料 MATERIAL	数量 QTY	図番 DWG NO.	備考 REMARKS
FAP-330	リモコン分配器 TITLE					
承認 APPROVED	2007.3.14 M. IMAI	92	77.1/AV40			
検出 CHECKED	2007.2.22 M. SAITO	32				
製図 DRAWN	2007.2.17 S. N.L.L.	72				
FAP-330		0.3 kg	C7235-G03-A			

FURUNO ELECTRIC CO., LTD.

FURUNO

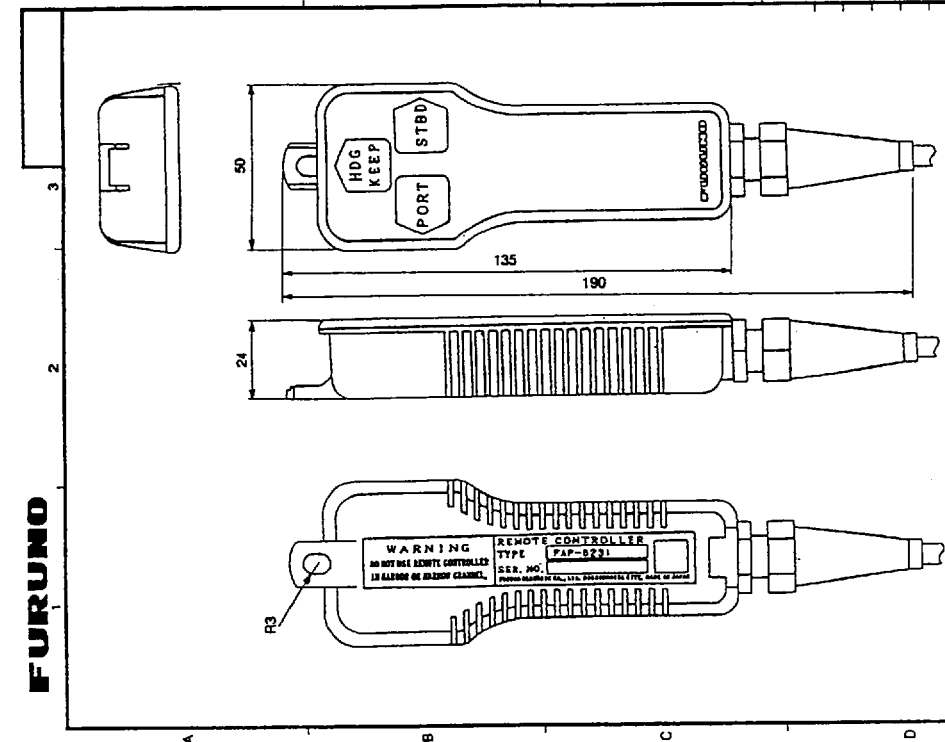

品名 ITEM	名称 NAME	数量 QTY	材料 MATERIAL	数量 QTY	図番 DWG NO.	備考 REMARKS
FAP-300	ドッジリモコン DODGE TYPE REMOTE CONTROLLER TITLE					
承認 APPROVED	SEP. 6 '93 M. IEDA					
検出 CHECKED	SEP. 1 '93 TAKAHASHI					
製図 DRAWN	AUG. 28 '93 S. MISHI					
FAP-300		0.1 kg	C7237-G06-A			

FURUNO ELECTRIC CO., LTD.

FURUNO

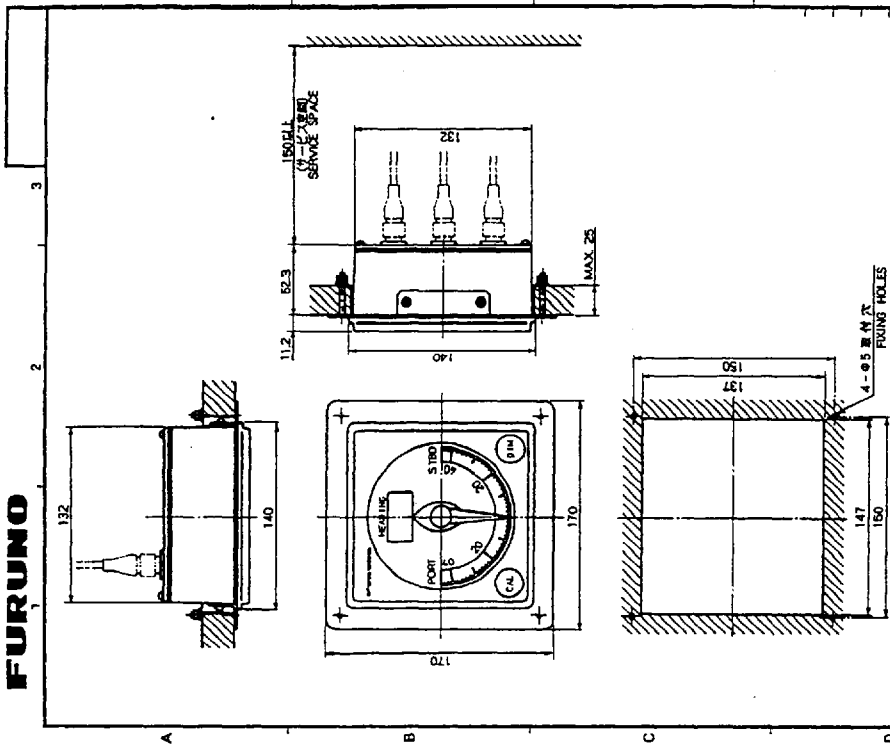

1:1 縮小寸法
CUTTING DIMENSIONS

品番 FAP-300	品名 FAP-300	材料 MATERIAL	数量 Q'TY	図番 DWG. NO.	備註 REMARKS
承認 APPROVED	承認者 T. NAKANO	承認日 JUN. 15. '92	承認者 T. NAKANO	承認日 JUN. 15. '92	備註 舵角表示器 (777277) (F)
検閲 CHECKED	検閲者 N. SAITO	検閲日 JUN. 15. '92	検閲者 N. SAITO	検閲日 JUN. 15. '92	備註 RUDDER TELLTALE FAP-6501 (FLUSH MOUNT F)
描画 DRAWN	描画者 S. NISHII	描画日 JUN. 15. '92	描画者 S. NISHII	描画日 JUN. 15. '92	備註 重量 1.4 kg C7235-G09-C

FURUNO ELECTRIC CO., LTD.

FURUNO

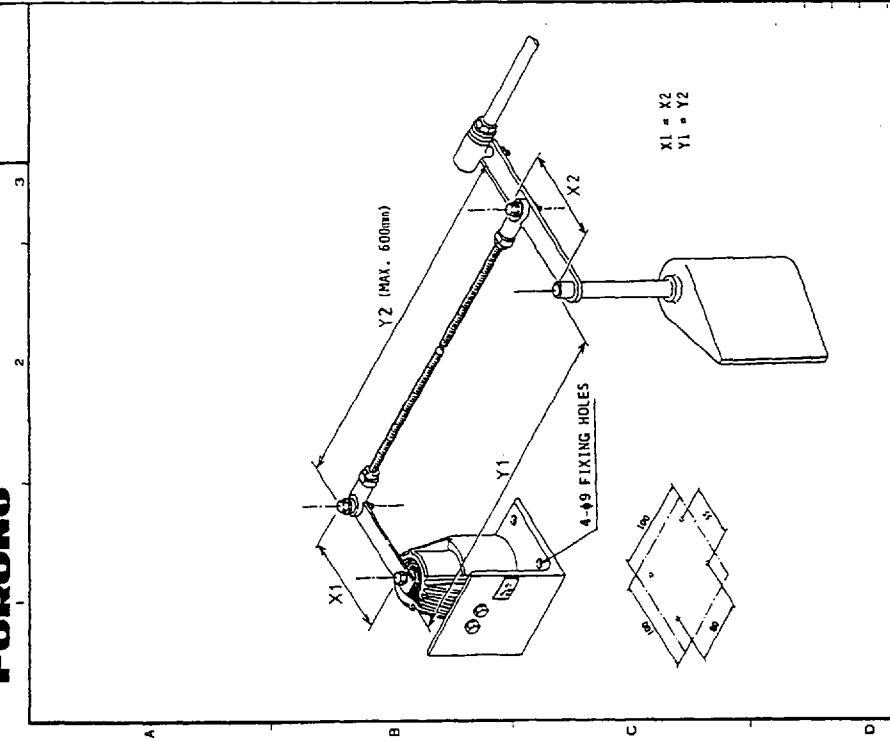

(The unit may be installed at either side of the rudder.)

品番 RUV-13-10	品名 RUV-13-10	材料 MATERIAL	数量 Q'TY	図番 DWG. NO.	備註 REMARKS
承認 APPROVED	承認者 T. NAKANO	承認日 JUN. 15. '92	承認者 T. NAKANO	承認日 JUN. 15. '92	備註 RUDDER REFERENCE UNIT INSTALLATION
検閲 CHECKED	検閲者 N. SAITO	検閲日 JUN. 15. '92	検閲者 N. SAITO	検閲日 JUN. 15. '92	備註
描画 DRAWN	描画者 S. NISHII	描画日 JUN. 15. '92	描画者 S. NISHII	描画日 JUN. 15. '92	備註 重量 E7227-101-A

FURUNO ELECTRIC CO., LTD.